

Heyco® HEYCaps,  
Nylon Finishing  
Plugs and Venting  
Solutions  
- 2015 -

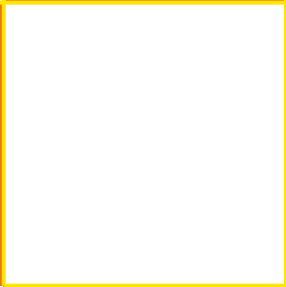

**HEYCO**®

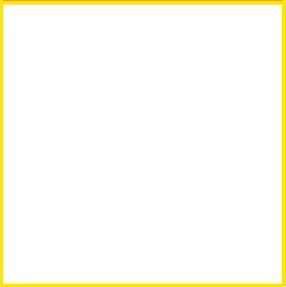

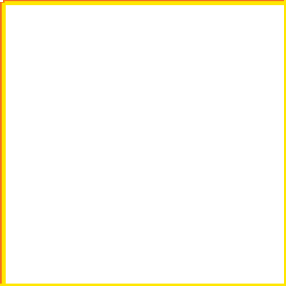
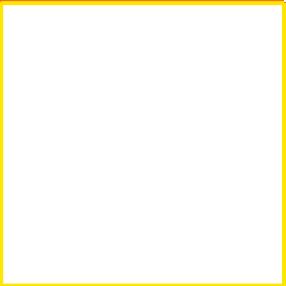
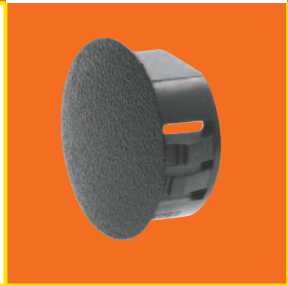
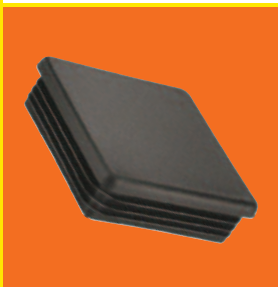

**CONTENTS**

Heyco® Dome Plugs ..... 6-25

Heyco® Thick Panel Dome Plugs ..... 6-26

Heyco® Shorty Plugs ..... 6-27

Heyco® Thin Panel Dome Plugs ..... 6-28

Heyco® Halogen and Phosphorus-Free 94V-0 Hole Plugs ..... 6-29

Heyco® Extra Dome Plugs ..... 6-30

Heyco® Snap-In Metric Dome Plugs ..... 6-30

Heyco® Glossy and Thick Panel Glossy Plugs ..... 6-31

Heyco® Pry Out Plugs - Standard and Prong Finger Designs ..... 6-32

Heyco® Metric Ergonomic Plugs ..... 6-33

Heyco® Insulation Plug ..... 6-33

Heyco® Double D Hole Plugs ..... 6-34

Heyco® Rectangular Blanking and Connector Port Plugs ..... 6-34

Heyco® Window “View Port” Plugs ..... 6-35

Heyco® Shorty and Oval Window “View Port” Plugs ..... 6-36

Heyco® Knock-Out Seals and Thick Panel Knock-Out Seals ..... 6-37

Heyco® V-0 Knock-Out Seals ..... 6-37

Heyco® V-0 Liquid Tight Hole Plugs - Standard 85 and Low 75 Durometer Plugs ..... 6-38

Heyco® Nylon Liquid Tight Threaded Plugs ..... 6-39

HEYCo-molded™ Liquid Tight Break-Thru Plugs ..... 6-40

HEYCap™ D-Subminiature and Electro Miniature Protection Caps ..... 6-41

Heyco® Nylon D-Subminiature Mounting Hole Plugs ..... 6-42

Heyco® IEC-14 Plug ..... 6-42

Heyco® Connector Caps and Plugs ..... 6-43

Heyco® PG and Metric Threaded Plugs - Plastic and Nickel-Plated Brass ..... 6-44

Heyco® Threaded Plugs for Straight Threaded Ports – NPS, SAE and ISO ..... 6-45

Heyco® Push-In Threaded Plugs for SAE and NPT Threaded Ports ..... 6-46

Heyco® TEMPlugs™ for NPT Threaded Ports ..... 6-46

HEYCap™ Tapered Plugs and Caps – NPT & SAE ..... 6-47, 6-48

Heyco® LDPE Sheet Metal Plugs – Recessed and Flushed Head ..... 6-49

HEYCaps™ and Plugs for Round Tubing – Clearance and Ribbed Fit ..... 6-50

Heyco® Plugs for Square Tubing – Clearance and Ribbed Fit ..... 6-51

Heyco® Ergonomic Plugs for Square Tubing – Vinyl ..... 6-52

Heyco® Plugs for Rectangular Tubing – Ribbed Fit ..... 6-52

Heyco® Stock and Custom Colors for Dome Plugs and Shorty Plugs ..... 6-53

Heyco® Vent Plugs and Thick Panel Vent Plugs ..... 6-54

HEYClean™ Filter Insert Vent Plugs ..... 6-55

Heyco® Louvered Plugs ..... 6-56

HEYClean™ Filter Insert Louvered Plugs ..... 6-56

Heyco® Threaded Vent Plugs ..... 6-57

HEYClean™ Liquid Tight Threaded Vent Plugs ..... 6-58

HEYClean™ Liquid Tight Snap-In Vent Plugs ..... 6-58

HEYClean™ Brass Pressure Equalization and Drain Plugs ..... 6-59

HEYClean™ Drain Plug Brass Locknuts ..... 6-59

Heyco® Fan Guards and Fan Guard Rivets ..... 6-60

Heyco® Fan Mounts ..... 6-61

Heyco® Strain Reliever ..... Back Cover



**What's New...**

**not previously released**

New Shorty Plugs (SP 307, SP 390 & SP 687) ..... 6-27

New Thin Panel Dome Plug (SP 512N) ..... 6-28

Thick Panel Halogen and Phosphorus-Free 94 V-0 Plugs ..... 6-29

New Snap-In Metric Dome Plugs  
(MDP 13, MDP 22, MDP 28 & MDP 34) ..... 6-30

Pry Out Plugs - Prong Finger Design ..... 6-32

New Rectangular Blanking & Connector Port Plug (RP95-130-1) ..... 6-34

Heyco Nylon Liquid Tight Threaded Plugs - V0 ..... 6-39

Heyco Connector Caps and Plugs ..... 6-43

New Plastic PG Threaded Plug (TP PG 42) ..... 6-44

Nickel-Plated Brass PG and Metric Threaded Plugs ..... 6-44

**Ask About Heyco® LabKits**

**Heyco® Hole Plugs LabKit #3  
(Part No. 2997)**

**Use Heyco LabKits!**

- Heyco LabKits are perfect for product design departments, experimental labs, and for all prototype work.
- Heyco Kits contain an assortment of our most popular plugs.
- Heyco also offers LabKits for Liquid Tight Cordgrips, Strain Relief Bushings, Bushings, Hardware, Power Components, and Grommets.





- **Close unneeded panel holes and electrical knockouts.**
- Quick and easy installation.
- Convex, matte finish head tapers to thin edge (Except DP-187).
- Multiple sizes for use in .187” (4,7 mm) to 6.000” (152,4 mm) diameter holes.
- Lock firmly into panel up to .250” (6,4 mm) thick.
- Locking fingers in fractional increments up to the maximum panel thickness.
- Approximate Head Thickness: .062” (1,6 mm). Thickness may vary.
- For Snap-In Metric Dome Plugs see page 6-30.

## Heyco® Dome Plugs

Mounting Hole Diameter Range: .187” (4,7 mm) to 6.000” (152,4 mm)

MOUNTING HOLE DIAMETER		PART NO.			DESCRIPTION	PART DIMENSIONS			
in.	mm.	Black	White	Colors xx**		A Head Diameter		B Overall Height	
					in.	mm.	in.	mm.	
Single Locking Step for Panel Thickness up to .062” (1,6 mm)									
.187	4,7	<b>2590</b>	<b>2591</b>	2592xx	DP 187*	.25	6,4	.23	5,9
.250	6,4	<b>2607</b> <b>2603</b>	<b>2608</b> <b>2604</b>	2609xx 2605xx	DP 250-040† DP 250	.31	7,9	.31	7,9
.312	7,9	<b>2613</b>	<b>2614</b>	2615xx	DP 312	.38	9,5		
Multiple Locking Steps for Panel Thickness up to .125” (3,2 mm)									
.375	9,5	<b>2617</b>	<b>2618</b>	2619xx	DP 375	.47	11,9	.41	10,3
.437	11,1	<b>2633</b>	<b>2634</b>	2635xx	DP 437	.53	13,5		
.500	12,7	<b>2643</b>	<b>2644</b>	2645xx	DP 500	.56	14,2		
.562	14,3	<b>2653</b>	<b>2654</b>	2655xx	DP 562	.66	16,7		
.625	15,9	<b>2663</b>	<b>2664</b>	2665xx	DP 625	.72	18,2		
.687	17,4	<b>2673</b>	<b>2674</b>	2675xx	DP 687	.78	19,8		
.750	19,1	<b>2683</b>	<b>2684</b>	2685xx	DP 750	.92	23,4		
.812	20,6	<b>2693</b>	<b>2694</b>	2695xx	DP 812	.99	25,1		
.875	22,2	<b>2703</b>	<b>2704</b>	2705xx	DP 875	1.02	25,8	.45	11,5
1.000	25,4	<b>2713</b>	<b>2714</b>	2715xx	DP 1000	1.20	30,6		
1.093 - 1.125	27,8 - 28,6	<b>2723</b>	<b>2724</b>	2725xx	DP 1093	1.22	30,9		
1.187	30,1	<b>2733</b>	<b>2734</b>	2735xx	DP 1187	1.33	33,8		
1.250	31,7	<b>2740</b>	<b>2741</b>	2742xx	DP 1250	1.38	34,9		
1.375	34,9	<b>2753</b>	<b>2754</b>	2755xx	DP 1375	1.50	38,1		
1.500	38,1	<b>2763</b>	<b>2764</b>	2765xx	DP 1500	1.67	42,4		
1.750	44,5	<b>2773</b>	<b>2774</b>	2775xx	DP 1750	1.92	48,7		
2.000	50,8	<b>2783</b>	<b>2784</b>	2785xx	DP 2000	2.17	55,1		
Multiple Locking Steps for Panel Thickness up to .250” (6,4 mm)									
2.093 - 2.125	53,2 - 54,0	<b>2403</b>	<b>2404</b>	***	DP 2.093	2.34	59,9	.75	19,1
2.250	57,2	<b>2411</b>	<b>2412</b>	2413xx	DP 2.25	2.48	63,0	.75	19,1
2.500	63,5	<b>2790</b>	<b>2791</b>	2792xx	DP 2.5	2.71	68,8		
3.000	76,2	<b>2455</b>	<b>2456</b>	2457xx	DP 3.0	3.16	80,3	.74	18,8
3.375	85,7	<b>2482</b>	<b>2483</b>	***	DP 3.375	3.66	92,9	.75	19,1
3.500	88,9	<b>2464</b>	<b>2465</b>	2466xx	DP 3.5	3.66	92,9		
4.000	101,6	<b>2473</b>	<b>2474</b>	2475xx	DP 4.0	4.17	105,8	.71	18,0
5.000	127,0	<b>2451</b>	<b>2452</b>	***	DP 5.0	5.24	133,0	.75	19,1
6.000	152,4	<b>2453</b>	<b>2454</b>	***	DP 6.0	6.22	157,9	.78	19,8

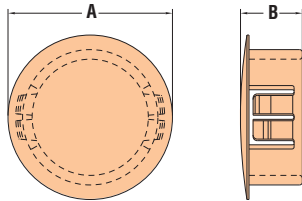

Standard colors black and white. Consult Heyco for other colors (see below)

\*Convex, glossy finish head.

\*\* xx indicates that, following the color match process, Heyco adds a two letter suffix to the Root Part No. shown. This suffix will identify your particular CUSTOM Color selection. Consult Heyco for molded nylon color chips for accurate matching. For details as well as information regarding our Stock Colors, see page 6-53.

\*\*\*Consult Heyco for root Part No.

† Max panel thickness is .040” (1,0 mm)

*Quick Specs*

Material	Nylon 6/6
Certifications	Recognized under the Component Program of Underwriters' Laboratories File E51579
	Certified by the Canadian Standards Association File 8919
Flammability Rating	94V-2
Temperature Range	-40°F (-40°C) to 221°F (105°C)



## Heyco® Thick Panel Dome Plugs

Mounting Hole Diameter Range: .375” (9,5 mm) to 2.000” (50,8 mm)

MOUNTING HOLE DIAMETER		PART NO.		DESCRIPTION	PART DIMENSIONS					
in.	mm.	Black	White		A Head Diameter		B Overall Height			
Single Locking Step for Panel Thickness up to .172” (4,4 mm)										
.375	9,5	2624	2625	DPT 375	.47	11,9	.41	10,3		
Multiple Locking Steps for Panel Thickness up to .250” (6,4 mm)										
.500	12,7	3004	3005	DPT 500	.57	14,5	.56	14,3		
.625	15,9	3006	3007	DPT 625 *	.73	18,5	.52	13,2		
.750	19,1	3008	3009	DPT 750 *	.92	23,4				
.812	19,6	2667	2668	DPT 812-500**	1.02	25,9	.88	22,4		
.875	22,2	3044	3045	DPT 875	1.02	25,9	.56	14,3		
1.000	25,4	3046	3047	DPT 1000	1.20	30,5				
1.093 - 1.125	27,8 - 28,6	3018	3019	DPT 1093	1.22	31,0				
1.187	30,1	3100	3101	DPT 1187	1.31	33,3				
1.250	31,8	3102	3103	DPT 1250	1.38	35,1				
1.375	34,9	3106	3107	DPT 1375	1.50	38,1				
1.500	38,1	3048	3049	DPT 1500	1.67	42,4				
1.750	44,5	3027	3028	DPT 1750	1.91	48,5				
2.000	50,8	3050	3051	DPT 2000	2.17	55,1			.56	14,2

- For use in panels thicker than .125” (3,2 mm).
- Close unneeded panel holes and electrical knock-outs.
- Locking fingers snap into holes with fingertip pressure for quick and easy installation.
- Convex, matte finish head tapers to a thin edge.
- Locking fingers in fractional increments up to the maximum panel thickness.
- Withstand a push back force of 35 pounds.
- Available in multiple sizes for use in .375” (9,5 mm) to 2.000” (50,8 mm) diameter holes for panel thickness up to .250” (6,4 mm).
- Approximate Head Thickness: .062” (1,6 mm). Thickness may vary.

Standard color black. Consult Heyco for other colors.  
 \*Single locking step for panel thickness up to .250” (6,4 mm).  
 \*\*For Panel Thickness from .20” (5,1 mm) to .50” (12,7 mm). AKA Whistle-free Plug.

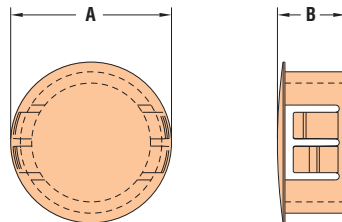

Material	Nylon 6/6
Certifications	Recognized under the Component Program of Underwriters' Laboratories, File E51579 (Thick Panel Dome Plugs only) Certified by Canadian Standards Association, File 8919
Flammability Rating	94V-2
Temperature Range	-40°F (-40°C) to 221°F (105°C)

Quick Specs



## Heyco® Shorty Plugs

Single Locking Step for Panel Thickness up to: .062" (1,6 mm)  
 Mounting Hole Diameter Range: .187" (4,7 mm) to 1.093" (27,8 mm)

- **Limited intrusion .125" (3,2 mm) inside the panel.**
- Quick and easy installation.
- Multiple sizes for mounting holes from .187" (4,7 mm) to 1.093" (27,8 mm).
- Approximate Head Thickness: .062" (1,6 mm).
- For Shorty Window Plugs see page 6-36.

MOUNTING HOLE DIAMETER		PART NO.			DESCRIPTION	PART DIMENSIONS			
in.	mm.	Black	White	Colors xx		A Head Diameter		B Overall Height	
.187	4,7	<b>2590</b>	<b>2591</b>	2592xx	DP 187†	.25	6,4	.23	5,9
.218	5,5	<b>1654</b>	<b>1655</b>	1656xx	SP 218	.28	7,1	.25	6,4
.281	7,1	<b>1660</b>	<b>1661</b>	1662xx	SP 281	.34	8,7		
<b>NEW!</b> .307	7,8	<b>1657</b>	<b>1658</b>	1659xx	SP 307	.37	9,4		
.312	7,9	<b>1678</b>	<b>1679</b>	1680xx	SP 312	.38	9,5		
.343	8,7	<b>1663</b>	<b>1664</b>	1665xx	SP 343	.41	10,3		
.375	9,5	<b>1681</b>	<b>1682</b>	1683xx	SP 375	.47	11,9		
<b>NEW!</b> .390	9,9	<b>1708</b>	<b>1709</b>	1710xx	SP 390				
.406	10,3	<b>1666</b>	<b>1667</b>	1668xx	SP 406				
.437	11,1	<b>1684</b>	<b>1685</b>	1686xx	SP 437	.53	13,5		
.468	11,9	<b>1669</b>	<b>1670</b>	1671xx	SP 468				
.500	12,7	<b>1687</b>	<b>1688</b>	1689xx	SP 500	.56	14,3		
.531	13,5	<b>1672</b>	<b>1673</b>	1674xx	SP 531	.59	15,1		
.593	15,1	<b>1675</b>	<b>1676</b>	1677xx	SP 593	.69	17,5		
.625	15,9	<b>1690</b>	<b>1691</b>	1692xx	SP 625	.72	18,3		
<b>NEW!</b> .687	17,4	<b>1719</b>	<b>1720</b>	1721xx	SP 687	.79	20,1		
.750	19,0	<b>1693</b>	<b>1694</b>	1695xx	SP 750	.84	21,4		
.781	19,8	<b>1696</b>	<b>1697</b>	1698xx	SP 781	.89	22,6		
.875	22,2	<b>1699</b>	<b>1700</b>	1701xx	SP 875	.97	24,6		
1.000	25,4	<b>1702</b>	<b>1703</b>	1704xx	SP 1000	1.20	30,5		
1.093	27,8	<b>1705</b>	<b>1706</b>	1707xx	SP 1093	1.22	31,0		

Standard colors black or white. Consult Heyco for other colors (see below).  
 † Convex, glossy finish head.  
 xx indicates that, following the color match process, Heyco adds a two letter suffix to the Root Part No. shown. This suffix will identify your particular CUSTOM Color selection. Consult Heyco for molded nylon color chips for accurate matching. For details as well as information regarding our Stock Colors, see page 6-53.

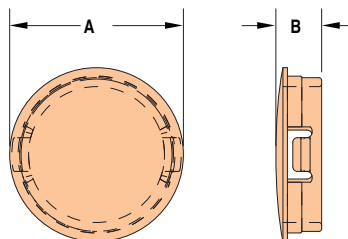

*Quick Specs*

Material: Nylon 6/6  
 Certifications: Recognized under the Component Program of Underwriters' Laboratories File E51579  
 Certified by the Canadian Standards Association File 8919  
 Flammability Rating: 94V-2  
 Temperature Range: -40°F (-40°C) to 221°F (105°C)



## Heyco® Thin Panel Dome Plugs

Multiple Locking Steps for Panels as Thin as .020" (0,5 mm)  
Mounting Hole Diameter Range: .218" (5,5 mm) to .875" (22,2 mm)\*

PANEL DIMENSIONS				PART NO.		DESCRIPTION	PART DIMENSIONS				
Thickness at Locking Finger Steps		Mounting Hole Diameter*		Black	White		A		B		
in.	mm.	in.	mm.			Head Diameter	in.	mm.	Overall Height	in.	mm.

Three Steps to .048" (1,2 mm) thick

.020 .032 .048	0,5 0,8 1,2	.218	5,5	<b>1654N</b>	<b>1655N</b>	SP 218N	.28	7,1	.25	6,4
		.250	6,4	<b>2607N</b>	<b>2608N</b>	SP 250N	.31	7,9		
		.281	7,1	<b>1660N</b>	<b>1661N</b>	SP 281N	.34	8,7		
		.312	7,9	<b>1678N</b>	<b>1679N</b>	SP 312N	.38	9,5		
		.343	8,7	<b>1663N</b>	<b>1664N</b>	SP 343N	.41	10,3		
		.375	9,5	<b>1681N</b>	<b>1682N</b>	SP 375N	.47	11,9		

Five Steps to .064" (1,6 mm) thick

.020 .032 .040 .048 .064	0,5 0,8 1,0 1,2 1,6	.500	12,7	<b>1687N</b>	<b>1688N</b>	SP 500N	.56	14,3	.25	6,4
		.512	13,0	<b>1716N</b>	<b>1717N</b>	SP 512N				
		.625	15,9	<b>1690N</b>	<b>1691N</b>	SP 625N				
		.750	19,1	<b>1693N</b>	<b>1694N</b>	SP 750N				
		.875	22,2	<b>1699N</b>	<b>1700N</b>	SP 875N				

Standard color black. Consult Heyco for other colors.

\*Consult Heyco for other Mounting Hole Diameters. Our Axcell Rapid Response Team is ready to meet your requirements.

- Provide a flush, finished fit in panels as thin as .020" (0,5 mm).
- Quick and easy installation.
- Multiple sizes for mounting holes from .218" (5,5 mm) to .875" (22,2 mm).
- Consult Heyco for other Thin Panel Mounting Hole Diameters.
- Lock firmly in panels up to .064" (1,6 mm) thick.

**NEW!**

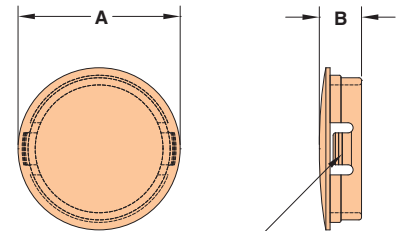

MULTIPLE FINGER STEPS FOR TIGHT PANEL FIT

## Heyco® Thin Panel versus Shorty Plugs

Choose from Multiple Locking Steps, for the Fit and Finish Your Application Requires

Mounting Hole Diameter	PANEL DIMENSIONS					PART NO.		DESCRIPTION	
	Maximum Thickness Locking Steps					Black	White		
	inches/millimeters								
in.	mm.	.020 0,5	.032 0,8	.040 1,0	.048 1,2	.064 1,6			
.218	5,5	x	x		x		<b>1654N</b>	<b>1655N</b>	SP 218N
						x	<b>1654</b>	<b>1655</b>	SP 218
.250	6,4	x	x		x		<b>2607N</b>	<b>2608N</b>	SP 250N
.281	7,1	x	x		x		<b>1660N</b>	<b>1661N</b>	SP 281N
						x	<b>1660</b>	<b>1661</b>	SP 281
.312	7,9	x	x		x		<b>1678N</b>	<b>1679N</b>	SP 312N
						x	<b>1678</b>	<b>1679</b>	SP 312
.343	8,7	x	x		x		<b>1663N</b>	<b>1664N</b>	SP 343N
						x	<b>1663</b>	<b>1664</b>	SP 343
.375	9,5	x	x		x		<b>1681N</b>	<b>1682N</b>	SP 375N
						x	<b>1681</b>	<b>1682</b>	SP 375
.500	12,7	x	x	x	x	x	<b>1687N</b>	<b>1688N</b>	SP 500N
						x	<b>1687</b>	<b>1688</b>	SP 500
.625	12,7	x	x	x	x	x	<b>1690N</b>	<b>1691N</b>	SP 625N
						x	<b>1690</b>	<b>1691</b>	SP 625
.750	19,1	x	x	x	x	x	<b>1693N</b>	<b>1694N</b>	SP 750N
						x	<b>1693</b>	<b>1694</b>	SP 750
.875	22,2	x	x	x	x	x	<b>1699N</b>	<b>1700N</b>	SP 875N
						x	<b>1699</b>	<b>1700</b>	SP 875

Material  
Certifications



Nylon 6/6  
Recognized under the Component Program of Underwriters' Laboratories, File E51579



Certified by Canadian Standards Association, File 8919

Flammability Rating  
Temperature Range

94V-2  
-40°F (-40°C) to 221°F (105°C)

Quick  
Specs



- **Molded from a nylon material which, in the event of a fire, will not burn and will not produce toxic gases.** Also formulated for sunlight resistance. Other Heyco products are available in this material—please consult Heyco.
- Close unneeded panel holes.
- Quick and easy installation.
- Convex, matte finish head tapers to a thin edge (Except HFP-187 glossy finish).
- Lock firmly into panel up to .125” (3,2 mm) thick.
- Locking fingers in fractional increments up to the maximum panel thickness.
- Approximate Head Thickness: .062” (1,6 mm). Thickness may vary.
- Multiple sizes for use in .187” (4,7 mm) to 2.000” (50,8 mm) diameter holes. Consult Heyco for larger sizes.

## Heyco® Halogen and Phosphorus-Free 94V-0 Hole Plugs

Heat Stabilized • Self Extinguishing • Nontoxic • UV Resistant  
 Mounting Hole Diameter Range: .187” (4,7 mm) to 2.000” (50,8 mm)

MOUNTING HOLE DIAMETER		PART NO.	DESCRIPTION	PART DIMENSIONS			
in.	mm.			Black	A Head Diameter		B Overall Height
				in.	mm.	in.	mm.

Single Locking Step for Panel Thickness up to .062” (1,6 mm)

.187	4,7	<b>2593</b>	HFP 187*	.25	6,4	.24	6,1
.250	6,4	<b>2606</b>	HFP 250	.31	7,9	.31	7,9
.312	7,9	<b>2616</b>	HFP 312	.38	9,5		

Multiple Locking Steps for Panel Thickness up to .125” (3,2 mm)

.375	9,5	<b>2623</b>	HFP 375	.47	11,9	.41	10,3
.437	11,1	<b>2636</b>	HFP 437	.53	13,5		
.500	12,7	<b>2646</b>	HFP 500	.58	14,7		
.625	15,9	<b>2666</b>	HFP 625	.72	18,2		
.750	19,1	<b>2686</b>	HFP 750	.92	23,4	.45	11,5
.875	22,2	<b>2706</b>	HFP 875	1.02	25,8		
1.000	25,4	<b>2716</b>	HFP 1000	1.20	30,6		
1.093 - 1.125	27,8 - 28,6	<b>2729</b>	HFP 1093	1.22	30,9		
1.250	31,7	<b>2749</b>	HFP 1250	1.38	34,9	.47	11,9
1.375	34,9	<b>2759</b>	HFP 1375	1.50	38,1		
1.500	38,1	<b>2769</b>	HFP 1500	1.69	42,8		
1.750	44,5	<b>2779</b>	HFP 1750	1.92	48,7		
2.000	50,8	<b>2789</b>	HFP 2000	2.17	55,1		

Multiple Locking Steps for Panel Thickness up to .250” (6,4 mm)

**ALL NEW PRODUCTS**

.500	12,7	<b>3004F</b>	HFPT 500	.58	14,7	.56	14,3
.625	15,9	<b>3006F</b>	HFPT 625 *	.73	18,5	.52	13,2
.750	19,1	<b>3008F</b>	HFPT 750 *	.91	23,1	.56	14,3
.875	22,2	<b>3044F</b>	HFPT 875	1.02	25,8		
1.000	25,4	<b>3046F</b>	HFPT 1000	1.20	30,6		
1.093-1.125	27,8-28,6	<b>3018F</b>	HFPT 1093	1.22	30,9		
1.250	31,7	<b>3102F</b>	HFPT 1250	1.38	34,9	.58	14,7
1.375	34,9	<b>3106F</b>	HFPT 1375	1.50	38,1		
1.500	38,1	<b>3048F</b>	HFPT 1500	1.67	42,4		
1.750	44,5	<b>3027F</b>	HFPT 1750	1.91	48,4		
2.000	50,8	<b>3050F</b>	HFPT 2000	2.17	55,1		

Standard color black.  
 \*Convex, glossy finish head.

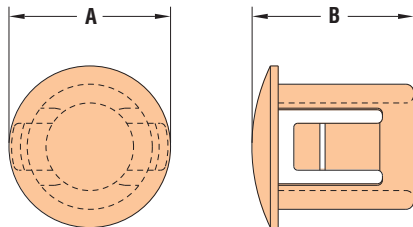

**SINGLE PANEL THICKNESS DESIGN**

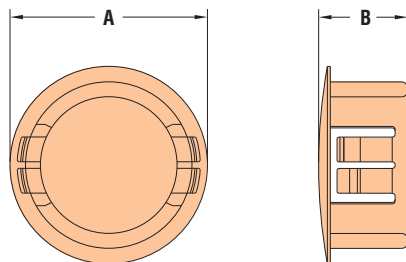

**MULTIPLE PANEL THICKNESS DESIGN**

*Quick Specs*

Material  
 Certifications



Nylon 6/6  
 Recognized under the Component Program of Underwriters' Laboratories File E51579



Certified by the Canadian Standards Association File 8919

Flammability Rating  
 Temperature Range

94V-0  
 -40°F (-40°C) to 221°F (105°C)





## Heyco® Extra Dome Plugs

Multiple Locking Steps for Panel Thickness up to .250" (6,4 mm)

MOUNTING HOLE DIAMETER		PART NO.		DESCRIPTION	PART DIMENSIONS					
in.	mm.	Black	White		A Head Diameter		B Overall Height		C Inside Height	
3.0	76,2	2442	2443	EDP 3.0	3.22	81,8	1.37	34,8	1.26	32,0
5.0	127,0	2444	2445	EDP 5.0	5.22	132,6	1.41	35,8	1.31	33,3

Standard colors black. Consult Heyco for other colors.

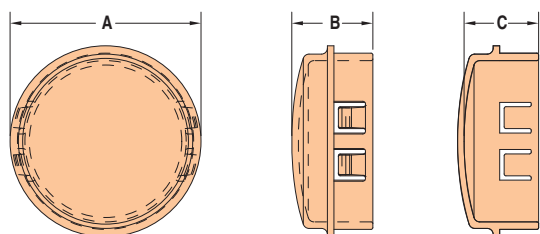

- **Extra dome height** for additional clearance under the top.
- Consult Heyco for additional sizes.
- Lock firmly into panels up to .250" (6,4 mm) thick.
- Locking fingers in fractional increments up to the maximum panel thickness.
- Not UL Recognized.

## Heyco® Snap-In Metric Dome Plugs

Multiple Locking Steps for Panel Thickness up to 4,1 mm (.162")

Mounting Hole Diameter Range: 13,0 mm (.512") to 34,2 mm (1.347")

	MOUNTING HOLE DIAMETER		PART NO.		DESCRIPTION	PART DIMENSIONS			
	mm.	in.	Black	White		A Head Diameter		B Overall Height	
<b>NEW!</b>	13,0	.512	2203	2204	MDP 13	14,2	.56	10,3	.406
	16,0	.630	2128	2130	MDP 16	18,5	.73		
	20,0	.787	2131	2132	MDP 20	22,6	.89		
<b>NEW!</b>	22,0	.866	2205	2206	MDP 22	25,9	1.02	11,5	.453
	25,0	.984	2133	2134	MDP 25	29,8	1.17		
<b>NEW!</b>	28,0	1.102	2215	2216	MDP 28	31,2	1.23		
	32,0	1.260	2135	2136	MDP 32	35,3	1.38		
<b>NEW!</b>	34,2	1.347	2218	2219	MDP 34	38,1	1.50		

Standard color black. Consult Heyco for other colors.

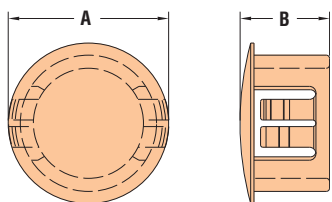

- Multiple sizes for use in **13,0 mm (.512") to 34,2 mm (1.347") diameter holes**. For other metric sizes, consult Heyco.
- Close unneeded panel holes.
- Quick and easy installation.
- Convex, matte finish head tapers to a thin edge.
- Lock firmly into panel up to 4,1 mm (.162") thick.
- Approximate Head Thickness: 1,6 mm (.062").
- For **Threaded Metric Plugs**, see page 6-44.
- For our complete range of Dome Plugs, see page 6-25.



Material  
Certifications

Nylon 6/6  
 Recognized under the Component Program of Underwriters' Laboratories, File E51579 (MDP's only)  
 Certified by Canadian Standards Association, File 8919 (MDP's only)

Flammability Rating  
Temperature Range

94V-2  
-40°F (-40°C) to 221°F (105°C)

Quick  
Specs



- **Smooth, glossy head** provides easy glide and shiny finish.
- Close unneeded panel openings.
- Locking fingers snap into holes with fingertip pressure for quick and easy installation.
- Locking fingers in fractional increments up to the maximum panel thickness.
- Multiple sizes for use in .187” (4,7 mm) to 2.000” (50,8 mm) diameter holes.
- Lock firmly in panel up to .125” (3,2 mm) thick. (G parts)
- For use in panels thicker than .125” (3,2 mm). (GPT parts)
- Withstand a push back force of 35 pounds.

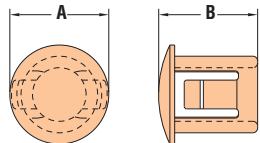

**SINGLE PANEL THICKNESS DESIGN**

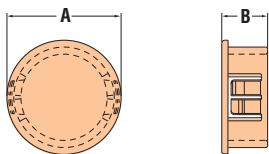

**MULTIPLE PANEL THICKNESS DESIGN**

## Heyco® Glossy and Thick Panel Glossy Plugs

Mounting Hole Diameter Range: .187” (4,7 mm) to 2.000” (50,8 mm)

MOUNTING HOLE DIAMETER		PART NO.		DESCRIPTION	PART DIMENSIONS			
in.	mm.	Black	White		A Head Diameter		B Overall Height	
					in.	mm.	in.	mm.
Single Locking Step for Panel Thickness up to .062” (1,6 mm)								
.187	4,7	2590	2591	DP 187*	.25	6,4	.23	5,9
.250	6,4	2600	2601	G 250	.31	7,9	.31	7,9
.312	7,9	2610	2611	G 312	.38	9,5		
Multiple Locking Steps for Panel Thickness up to .125” (3,2 mm)								
.375	9,5	2620	2621	G 375	.47	11,9	.41	10,3
.437	11,1	2630	2631	G 437	.53	13,5		
.500	12,7	2640	2641	G 500	.56	14,3		
.562	14,3	2650	2651	G 562	.66	16,7		
.625	15,9	2660	2661	G 625	.73	18,6		
.750	19,1	2680	2681	G 750	.86	21,8	.45	11,5
.875	22,2	2700	2701	G 875	.95	24,2		
1.000	25,4	2710	2711	G 1000	1.13	28,6		
1.093 - 1.125	27,8 - 28,6	2720	2721	G 1093	1.22	30,9		
1.187	30,1	2730	2731	G 1187	1.31	33,3		
1.375	34,9	2760	2761	G 1375	1.49	37,7	.56	14,3
1.500	38,1	2770	2771	G 1500	1.61	40,8		
1.750	44,4	2780	2781	G 1750	1.88	47,6		
2.000	50,8	2795	2796	G 2000	2.13	54,8		
Multiple Locking Steps for Panel Thickness up to .250” (6,4 mm)								
.500	12,7	2430	2431	GPT 500	.56	14,3	.52	13,1
.625	15,9	3134	3135	GPT 625**	.72	18,3		
.750	19,1	3136	3137	GPT 750**	.85	21,6	.56	14,3
.875	22,2	3138	3139	GPT 875	.95	24,2		
1.000	25,4	3140	3141	GPT 1000	1.13	28,6		
1.093 - 1.125	27,8 - 28,6	3142	3143	GPT 1093	1.22	30,9		
1.187	30,1	3144	3145	GPT 1187	1.31	33,3		
1.375	34,9	2432	2433	GPT 1375	1.49	37,7	.56	14,3
1.500	38,1	2428	2429	GPT 1500	1.61	40,8		
1.750	44,4	2436	2437	GPT 1750	1.88	47,6		
2.000	50,8	2438	2439	GPT 2000	2.16	54,8		

Standard color black. Consult Heyco for other colors.

\*Convex, glossy finished head tapers to a thin edge.

\*\* Single locking steps for Panel Thickness up to .250” (6,4 mm)

*Quick Specs*

Material  
Certifications



Nylon 6/6  
Recognized under the Component Program of Underwriters' Laboratories, File E51579



Certified by Canadian Standards Association, File 8919

Flammability Rating  
Temperature Range

94V-2  
-40°F (-40°C) to 221°F (105°C)



## Heyco® Pry Out Plugs

### Standard Finger Design

Mounting Hole Diameter Range: .250" (6,4 mm) to 2.500" (63,5 mm)

MOUNTING HOLE DIAMETER		PART NO.		DESCRIPTION	PART DIMENSIONS					
in.	mm.	Black	White		A Head Diameter		B Overall Height			
					in.	mm.	in.	mm.		
Clearance Fit for Panel Thickness up to .156" (4,0 mm)										
.250	6,4	3053	3054	POP 250	.42	10,7	.33	8,3		
Clearance Fit for Panel Thickness up to .172" (4,4 mm)										
.312	7,9	3056	3057	POP 312	.51	12,9	.41	10,4		
.375	9,5	3059	3060	POP 375	.58	14,7				
.437	11,1	3062	3063	POP 437	.61	15,5				
.500	12,7	3065	3066	POP 500	.67	17,0				
.562	14,3	3068	3069	POP 562	.73	18,6				
.625	15,9	3071	3072	POP 625	.80	20,2				
.687	17,4	3074	3075	POP 687	.89	22,6				
.750	19,0	3077	3078	POP 750	.97	24,6				
.812	20,6	3080	3081	POP 812	1.03	26,2				
.875	22,2	3083	3084	POP 875	1.08	27,4				
1.000	25,4	3086	3087	POP 1000	1.22	30,9	.45	11,5		
1.093	27,8	3089	3090	POP 1093	1.30	32,9				
1.187	30,1	3092	3093	POP 1187	1.41	35,7				
1.250	31,8	3095	3096	POP 1250	1.45	36,9				
1.375	34,9	3098	3099	POP 1375	1.58	40,1				
Clearance Fit for Panel Thickness up to .250" (6,4 mm)										
1.500	38,1	3124	3125	POP 1500	1.72	43,6			.45	11,5
1.750	44,5	2973	2974	POP 1750	1.98	50,3			.48	12,2
2.000	50,8	2798	2799	POP 2000	2.22	56,4			.48	12,2
2.500	63,5	2975	2976	POP 2.5	2.69	68,4			.74	18,8

Standard color black. Consult Heyco for other colors.

### Prong Finger Design

Mounting Hole Diameter Range: .187" (4,7 mm) to .375" (9,5 mm)



WILL FIT THESE PANELS				PART NO.		DESCRIPTION	HEAD STYLE	PART DIMENSIONS							
MOUNTING HOLE DIAMETER		THICKNESS RANGE		Black	Natural			A Head Diameter		B Overall Height					
Minimum	Maximum	Minimum	Maximum			in.	mm.	in.	mm.						
in.	mm.	in.	mm.												
Clearance Fit for Panel Thickness Ranges Shown															
.187	4,7	.192	4,9	.031	0,8	.062	1,6	12170	12171	PPL 187	Glossy	.35	8,9	.18	4,6
.313	8,0	.318	8,1	.047	1,2	.156	4,0	12178	12179	PPL 313	Dome	.58	14,7	.41	10,4
.375	9,5	.380	9,7	.093	2,4	.312	7,9	12182	12183	PPL 375	Glossy	.19	12,4	.53	13,5

Standard color black and natural.

Material	Nylon 6/6
Certifications	Recognized under the Component Program of Underwriters' Laboratories, File E51579 (POP Plugs only) Certified by the Canadian Standards Association, File 8919 (POP Plugs only)
Flammability Rating	94V-2
Temperature Range	-40°F (-40°C) to 221°F (105°C) (POP Plugs only) 32°F (0°C) to 185°F (85°C) (PPL Plugs only)



- POP in closures for pipe and tubing ends.
- Retaining fingers without locking steps provide friction fit and allow removal of plug.
- Bumper protection.
- Flat, matte finish head.
- Multiple sizes for use in .250" (6,4 mm) to 2.500" (63,5 mm) diameter holes for panel thickness up to .250" (6,4 mm).
- Approximate Head Thickness: .062" (1,6 mm).

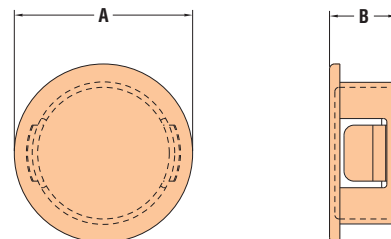

- Flexible and tapered prongs on plug will snugly lock in place with fingertip pressure, but can be removed & reused.
- Durable and non-conductive.
- Excellent dust protection for electronic equipment.
- Abrasion and vibration resistant.
- May be used as temporary or permanent hole plugs.
- Function as feet on small appliances.
- May be used to close tube ends.

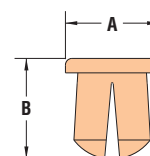



- Close unneeded sheet metal panel holes, *ergonomically*.
- Flush button head style.
- Quick, easy installation; quick, easy removal, too.
- Heyco Metric Ergonomic Plugs offer greater versatility because their pliable nature allows one plug size to fit a variety of different sized holes.
- Available in multiple sizes from 14,5 mm (.57”) through 34,0 mm (1.34”) diameter holes.

## Heyco® Metric Ergonomic Plugs

For Panel Thickness from 0,8 mm (.03”) to 2,0 mm (.08”)  
 Mounting Hole Diameter Range: 14,5 mm (.57”) to 34,0 mm (1.34”)

MOUNTING HOLE DIAMETER			PART NO.	DESCRIPTION	PART DIMENSIONS					
NOMINAL	DIAMETER RANGE				A	B		C		
mm.	mm.	in.	Black	Head Diameter	Bottom Diameter	Overall Height				
				mm.	mm.	mm.	mm.	in.		
15	14,5 - 16,0	.57 - .63	9690	SMP E-M15	25,0	.98	18,0	.71	7,8	.31
17	15,2 - 18,0	.65 - .71	9691	SMP E-M17	28,0	1.10	20,3	.80		
19	18,5 - 20,0	.73 - .79	9692	SMP E-M19	30,2	1.19	22,5	.89		
21	20,5 - 22,0	.81 - .87	9693	SMP E-M21	32,0	1.26	24,3	.96		
23	22,5 - 24,0	.87 - .95	9694	SMP E-M23	34,0	1.34	26,4	1.04		
25	24,5 - 26,0	.97 - 1.02	9695	SMP E-M25	35,0	1.38	28,0	1.10		
27	26,5 - 28,0	1.04 - 1.10	9696	SMP E-M27	38,0	1.50	30,3	1.19		
29	28,5 - 30,0	1.12 - 1.18	9697	SMP E-M29	40,0	1.58	32,3	1.27		
31	30,5 - 32,0	1.20 - 1.26	9698	SMP E-M31	42,0	1.65	34,3	1.35		
33	32,5 - 34,0	1.28 - 1.34	9699	SMP E-M33	44,0	1.73	36,3	1.43		

Standard color black.



- Closes cavity-fill insulation holes in wood and other type siding.
- Fills holes in surfaces of unspecified thickness including cabinetry, furniture, display cases—even masonry.
- Convex, matte finish head blends with various surfaces.
- Quick and easy installation with fingertip pressure (no tool required).
- Holds securely in hole.

## Heyco® Insulation Plug

No Maximum Panel Thickness

MOUNTING HOLE DIAMETER		PART NO.		DESCRIPTION	PART DIMENSIONS			
in.	mm.	Black	White		A		B	
					Head Diameter	Overall Height		
					in.	mm.	in.	mm.
1.000	25,4	3149	3150	IPW 1	1.23	31,3	.69	17,5

Standard color black. Consult Heyco for other colors.

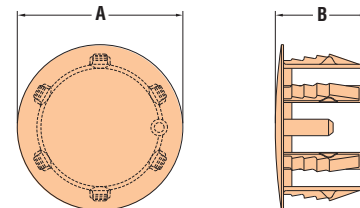

*Quick Specs*

Material	SMP E Flex Temp (Thermoplastic Rubber)
Material	IPW Nylon 6/6
Flammability Rating	94V-2
Temperature Range	(Both) -40°F (-40°C) to 221°F (105°C)



## Heyco® Double D Hole Plugs

For Mounting Holes with Flats

Multiple Locking Steps for Panel Thickness up to .125" (3,2 mm)



PANEL DIMENSIONS				PART NO.		DESCRIPTION	PART DIMENSIONS			
C		D		Black	White		A		B	
Mounting Hole Dia.		To Prevent Rotation						Head Diameter		Overall Height
in.	mm.	in.	mm.			in.	mm.	in.	mm.	
.375	9,5	.345	8,8	2617	2618	DP 375*	.47	11,9	.41	10,3
.437	11,1	.390	9,9	2488	2489	DD 437-390	.53	13,5		
.500	12,7	.445	11,3	2491	2492	DD 500-445	.55	14,7		
.562	14,3	.530	13,5	2494	2495	DD 562-530	.66	16,7		
.625	15,9	.550	14,0	2497	2498	DD 625-550	.73	18,5		
.750	19,1	.625	15,9	2503	2504	DD 750-625	.92	23,4		
.875	22,2	.770	19,5	2509	2510	DD 875-770	1.02	25,8	.45	11,5
				2511	-	DD 875-770-9**	.94	23,8		
1.109	28,2	1.000	25,4	2717	2718	DD 1109-1000	1.22	30,9		
2.000	50,8	1.875	47,6	2959	2963	DD 2000-1875	2.17	55,1	.48	12,1

Standard colors black and white. Consult Heyco for other colors.

\*On installation, DP 375 Locking Fingers must be aligned with Mounting Hole Flats.

\*\*Smaller than standard Head Diameter, for clearance situations.

- Close unwanted Strain Relief mounting holes or other double faced or Double D holes punched or molded with two opposing flats.
- Convex, matte finish head tapers to a thin edge.
- Quick and easy installation.
- Lock firmly in panels up to .125" (3,2 mm) thick.
- Locking fingers in fractional increments up to the maximum panel thickness.
- Approximate Head Thickness: .062" (1,6 mm). Thickness may vary.

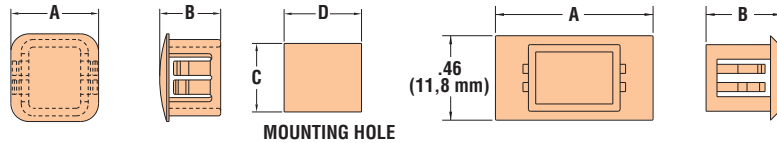

RP Series

3299, 3388, 3389

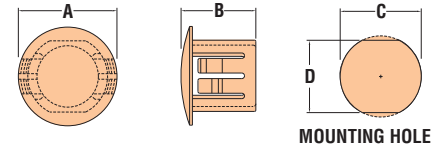

DD Series



## Heyco® Rectangular Blanking & Connector Port Plugs

Multiple Locking Steps for Various Panel Thicknesses

Maximum Thickness	PANEL DIMENSIONS				PART NO.	DESCRIPTION	PART DIMENSIONS				
	C		D				Black	A		B	
in.	mm.	Length	Width	in.	mm.			Head Dimensions	Overall Height		
		in.	mm.	in.	mm.		in.	mm.	in.	mm.	
.04	1,0	.27	6,9	.29	7,4	2512	RP 69-74*	.37 x .37	9,4 x 9,4	.33	8,4
.14	3,5	.37	9,5	.51	13,0	3299	RP 95-130-1**	.63	16,0	.41	10,5
						3388	RP 95-130**	.46 x .87	11,8 x 22		
				3389	RP 95-260**	.46 x 1.38	11,8 x 35				
.10	2,5	.45	11,5	.51	13,9	1890	RP 115-139	.58 x .58	14,7 x 14,7	.40	10,2
.16	4,0	.69	17,5	.69	17,5	1892	RP 175-175	.83 x .83	21,1 x 21,1	.47	11,9

Standard color black. Consult Heyco for other colors. \*Single locking step for Panel Thickness up to .04" (1,0 mm).

\*\* Connector port sizes.

- Blank unused rectangular panel holes.
- **PN 1890** - UR Recognized under the Component Program of Underwriters' Laboratories File E15331.
- **PN 1892** - UR Recognized under the Component Program of Underwriters' Laboratories File E51579 and CSA Certified by the Canadian Standards Association File 8919.

NEW!

Material  
Certifications

Nylon 6/6  
 Recognized under the Component Program of Underwriter Laboratories File E51579 (DD only)

Flammability Rating  
Temperature Range

94V-2  
-40°F (-40°C) to 221°F (105°C)

Quick  
Specs



Consult Heyco for Window Tints Other Than Clear

## Heyco® Window “View Port” Plugs

Mounting Hole Diameter Range: .187” (4,7 mm) to 2.000” (50,8 mm)

- Molded of **transparent** polycarbonate for internal viewing or light transmission.
- Snap into mounting holes with fingertip pressure—no tools required.
- Multiple sizes for use in .187” (4,7 mm) to 2.000” (50,8 mm) diameter holes.
- Lock firmly into panel up to .125” (3,2 mm) thick.
- Locking fingers in fractional increments up to the maximum panel thickness.
- Approximate Head Thickness: .062” (1,6 mm). Thickness may vary.
- **Available in a variety of tints –consult Heyco.**

MOUNTING HOLE DIAMETER		PART NO. Clear*	DESCRIPTION	PART DIMENSIONS			
in.	mm.			A Head Diameter		B Overall Height	
				in.	mm.	in.	mm.

Single Locking Step for Panel Thickness up to .062” (1,6 mm)

.187	4,7	<b>1300</b>	WP 187	.25	6,4	.23	5,9
.250	6,4	<b>1301</b>	WP 250	.31	7,9	.31	7,9
.312	7,9	<b>1302</b>	WP 312	.38	9,5		

Multiple Locking Steps for Panel Thickness up to .125” (3,2 mm)

.375	9,5	<b>1303</b>	WP 375	.47	11,9	.41	10,3
.437	11,1	<b>1304</b>	WP 437	.53	13,5		
.500	12,7	<b>1305</b>	WP 500	.56	14,3		
.625	15,9	<b>1307</b>	WP 625	.73	18,6		
.760	19,3	<b>1309</b>	WP 750	.86	21,8	.45	11,5
.875	22,2	<b>1311</b>	WP 875	.95	24,2		
1.000	25,4	<b>1312</b>	WP 1000	1.13	28,6		
1.093 - 1.125	27,8 - 28,6	<b>1313</b>	WP 1093	1.22	30,9		
1.375	34,9	<b>1314</b>	WP 1375	1.50	38,1		
1.500	38,1	<b>1316</b>	WP 1500	1.62	41,2		
1.750	44,5	<b>1318</b>	WP 1750	1.88	47,6		
2.000	50,8	<b>1319</b>	WP 2000	2.16	54,8		

\*Consult Heyco for Window Plugs in tinted colors.

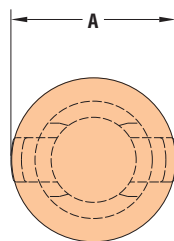
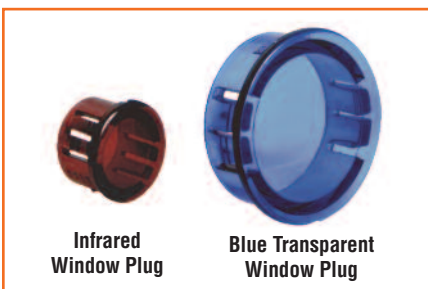

SINGLE PANEL THICKNESS DESIGN

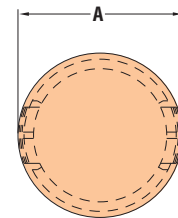
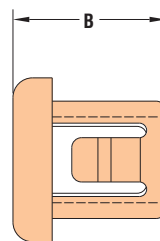

MULTIPLE PANEL THICKNESS DESIGN

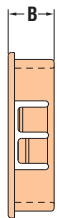

*Quick Specs*

Material	Polycarbonate
Flammability Rating	94V-2
Temperature Range	-40°F (-40°C) to 239°F (115°C)



## Heyco® Shorty Window “View Port” Plugs

Single Locking Step for Panel Thickness up to .062” (1,6 mm)  
Mounting Hole Diameter Range: .510” (13,0 mm) to 1.010” (25,7 mm)

MOUNTING HOLE DIAMETER		PART NO. Clear*	DESCRIPTION	PART DIMENSIONS			
in.	mm.			A Head Diameter		B Overall Height	
.510	13,0	1292	SWP 510	.56	14,3	.25	6,4
.635	16,1	1293	SWP 635	.73	18,6		
.760	19,3	1294	SWP 760	.86	21,8		
.885	22,5	1295	SWP 885	.95	24,2		
1.010	25,7	1296	SWP 1010	1.13	28,6		

\*Consult Heyco for Shorty Window Plugs in tinted colors.

- Lock firmly into panels up to .062” (1,6 mm) thick, with **limited intrusion** inside the panel.
- Molded of transparent polycarbonate for internal viewing or light transmission.
- Snap into mounting holes with fingertip pressure—no tools required.
- Locking fingers in fractional increments up to the maximum panel thickness.
- Multiple sizes for use in .510” (13,0 mm) to 1.010” (25,7 mm) diameter holes.
- Flammability Rating 94V-2.
- **Available in a variety of tints** —consult Heyco.

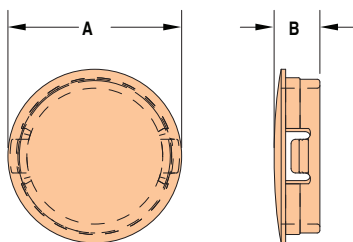

## Heyco® Oval Window “View Port” Plug

Multiple Locking Steps for Panel Thickness up to .125” (3,2 mm)

MOUNTING HOLE DIAMETER		PART NO. Clear*	DESCRIPTION	PART DIMENSIONS			
in.	mm.			Head Diameter		Overall Height	
see schematic		1299	OWP 875-2000	2.13 - 1.01	54,4 - 26,6	.46	11,7

\*Consult Heyco for Oval Window Plugs in tinted colors.

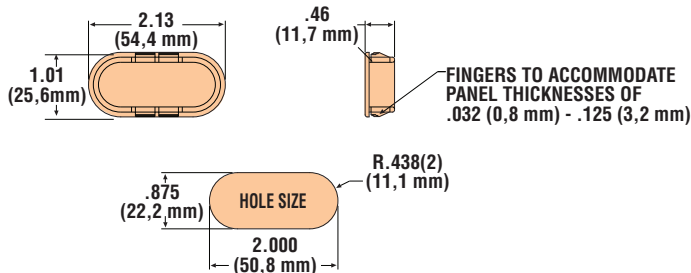

- **Large viewing window** for internal components.
- Locking fingers in fractional increments up to the maximum panel thickness.



Consult Heyco for Window Tints Other Than Clear

Material	Polycarbonate
Flammability Rating	94V-2
Temperature Range	-40°F (-40°C) to 239°F (115°C)

Quick Specs



- **Plug electrical knock-outs.**
- Molded in silver gray color to resemble galvanized steel.
- Install quickly with fingertip pressure (no tool required).
- Economical.
- Multiple trade sizes fit 1/2" to 2" knock-out holes.
- Lock firmly in boxes up to 1/8" thick, except for Part Number 4002 (KOS 2) and Thick Panel Knock-Out Seals (KOST's) which lock firmly in boxes up to 1/4" thick.
- Locking fingers in fractional increments up to the maximum panel thickness.
- Approximate Head Thickness: .062" (1,6 mm). Thickness may vary.
- To adapt a Knock-Out to accept a Heyco Strain Relief, see page 4-37 for Knock-Out Adapters in the Heyco Catalog.

## Heyco® Knock-Out Seals and Thick Panel Knock-Out Seals

Mounting Hole Diameter Range: 1/2" to 2" Electrical Knock-outs (.875" to 2.500" nominal)

MOUNTING HOLE DIAMETER		TRADE SIZE	PART NO. Silver Gray	DESCRIPTION	PART DIMENSIONS			
in.	mm.				A Head Diameter		B Overall Height	
					in.	mm.	in.	mm.

Multiple Locking Steps for Panel Thickness up to .125" (3,2 mm)

.875	22,2	1/2	3997	KOS 1/2	1.02	25,8	.45	11,5
1.093	27,8	3/4	3998	KOS 3/4	1.22	31,0		
1.375	34,9	1	3999	KOS 1	1.50	38,1		
1.750	44,5	1-1/4	4000	KOS 1-1/4	1.91	48,4		
2.000	50,8	1-1/2	4001	KOS 1-1/2	2.16	54,9		

Multiple Locking Steps for Panel Thickness up to .250" (6,4 mm)

.875	22,2	1/2	3991	KOST 1/2	1.02	25,8	.56	14,3
1.093	27,8	3/4	3992	KOST 3/4	1.22	31,0		
1.375	34,9	1	3993	KOST 1	1.50	38,1		
1.750	44,5	1-1/4	3994	KOST 1-1/4	1.91	48,4		
2.000	50,8	1-1/2	3995	KOST 1-1/2	2.16	54,9	.58	14,7
2.500	63,5	2	4002	KOS 2	2.73	69,3	.75	19,1

Standard color silver gray.



- **Molded from a nylon material which, in the event of a fire, will not burn and will not produce toxic gases.** Also formulated for sunlight resistance.

## Heyco® V-0 Knock-Out Seals

Multiple Locking Steps for Panel Thickness up to .125" (3,2 mm)  
Mounting Hole Diameter Range: 1/2" to 1-1/2" Electrical Knock-outs (.875" to 2.000" nominal)

MOUNTING HOLE DIAMETER		TRADE SIZE	PART NO. Black	DESCRIPTION	PART DIMENSIONS			
in.	mm.				A Head Diameter		B Overall Height	
					in.	mm.	in.	mm.

Standard color black.

*Quick Specs*

Material	Nylon 6/6
Certifications	Recognized under the Component Program of Underwriters' Laboratories, File E51579 Certified by Canadian Standards Association, File 8919
Flammability Rating	KOS: 94V-2, HFP 94V-0
Temperature Range	-40°F (-40°C) to 221°F (105°C)





## Heyco® V-0 Liquid Tight Hole Plugs Standard 85 Durometer Plugs

Maximum Panel Thickness .125" (3,2 mm)

Mounting Hole Diameter Range: .500" (12,7 mm) to 1.375" (34,9 mm)

MOUNTING HOLE DIAMETER		PART NO.	DESCRIPTION	UL or RA	PART DIMENSIONS					
					A Head Diameter		B Overall Height		C Head Thickness	
in.	mm.	Black			in.	mm.	in.	mm.	in.	mm.
.500	12,7	<b>3830</b>	KOS LT 500	RA	.91	23,1	.45	11,4	.29	7,4
.625	15,9	<b>3834</b>	KOS LT 625	RA	1.03	26,2	.47	11,9	.31	7,9
.750	19,1	<b>3831</b>	KOS LT 750	RA	1.15	29,2	.51	13,0	.35	8,9
.875	22,2	<b>3833</b>	KOS LT 1/2	UL	1.23	32,5	.50	13,5	.36	9,1
1.000	25,4	<b>3832</b>	KOS LT 1000	RA	1.41	35,8	.56	14,2		
1.093	27,8	<b>3835</b>	KOS LT 3/4	UL	1.53	38,6	.55	14,0	.40	10,2
1.375	34,9	<b>3837</b>	KOS LT 1	UL	1.78	45,2	.57	14,5	.42	10,7

Available in black only.

- Oil tight, rain tight, submersible.
- UL certified for outdoor applications.
- V0 Flammability rating.
- Install with fingertip pressure (no tool required).
- Multiple nominal sizes fit .500" (12,7 mm) to 1.000" (25,4 mm) true size mounting holes.
- Three trade sizes fit 1/2" to 1" knock-out holes.
- Lock firmly in boxes from .030" (0,8 mm) to .125" (3,2 mm) thick.
- True sizes are UL recognized under Underwriters' Laboratories File E51579 and CSA certified by Canadian Standard Association File 8919.
- Trade sizes are UL listed under Underwriters' Laboratories File E51579 and CSA certified by Canadian Standard Association File 081067C. **Now certified for NEMA 4 and 4X applications.**

## Low 75 Durometer Plugs

Maximum Panel Thickness .125" (3,2 mm)

Mounting Hole Diameter Range: .875" (22,2 mm) to 1.375" (34,9 mm)

MOUNTING HOLE DIAMETER*		PART NO.		DESCRIPTION	UL or RA	PART DIMENSIONS*					
		Black	Gray			A Head Diameter		B Overall Height		C Head Thickness	
in.	mm.					in.	mm.	in.	mm.	in.	mm.
.875	22,2	<b>3833FN</b>	<b>3833FP</b>	KOS LT 1/2 LD	UL	1.23	32,5	.53	13,5	.36	9,1
1.093	27,8	<b>3835FN</b>	<b>3835FP</b>	KOS LT 3/4 LD	UL	1.53	38,6	.55	14,0	.40	10,2
1.375	34,9	<b>3837FN</b>	<b>3837FP</b>	KOS LT 1 LD	UL	1.80	45,2	.56	14,3	.42	10,7

Standard colors black and gray.

\*Consult Heyco for other Liquid Tight Hole Plug sizes in Low Durometer material.

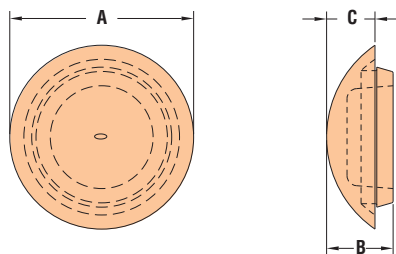

Material	85 Durometer 75 Durometer	TPE-Hardness 85 Shore A TPE-Hardness 75 Shore A
Certifications	Trade Sizes (1/2, 3/4, 1)	UL Listed under Underwriters' Laboratories File E51579 CSA Certified by Canadian Standard Association File 081067C
	True Sizes (all others)	RA Recognized under Underwriters' Laboratories File E51579 CSA Certified by Canadian Standard Association File 8919
Flammability Rating	94V-0	
Temperature Range	-81°F (-60°C) to 275°F (135°C)	

Quick Specs



## Heyco® Nylon Liquid Tight Threaded Plugs

Liquid Tight, with Integral Sealing Ring  
Hex Head with Slot

**NO O-RING  
REQUIRED!**

- **Integral sealing ring** ensures a superior seal at mounting hole location, every time.
- IP 68 Rated.
- Provide a liquid-tight seal up to 70 psi.
- UL Rated for Type NEMA 3R, 4 and 4X applications.
- Threaded plugs for hydraulic and pneumatic applications.
- Seal threaded openings and protect against contamination and moisture.
- Lower cost option over brass or steel plugs.
- Non-corrosive—resist salt water, weak acids, gasoline, alcohol, oil, grease, and common solvents.
- Resist oil and heat up to 221°F (105°C).
- Approximate Head Thickness: .21" (5,3 mm). Thickness may vary.
- Hex shaped head with slot for wrench or screwdriver installation.
- Electrically non-conductive Nylon 6/6.

THREAD TYPE/SIZE	PART NO.			DESCRIPTION	PART DIMENSIONS			
	Black	Gray	<b>NEW!</b> V-0 Black		A Wrenching Flats		B Overall Length	
					in.	mm.	in.	mm.

### NPT

NPT 1/4	<b>3544B</b>	<b>3544</b>	-	LTPP NPT 1/4	.63	16,0	.66	16,8
NPT 3/8	<b>3545B</b>	<b>3545</b>	-	LTPP NPT 3/8	.83	21,0	.69	17,5
NPT 1/2	<b>3546B</b>	<b>3546</b>	<b>V3546*</b>	LTPP NPT 1/2	.98	24,9	.81	20,6
NPT 3/4	<b>3547B</b>	<b>3547</b>	<b>V3547*</b>	LTPP NPT 3/4	1.29	32,8	.86	21,8
NPT 1*	<b>3548B</b>	<b>3548</b>	<b>V3548</b>	LTPP NPT 1	1.74	44,2	1.05	26,7
NPT 1-1/4*	<b>3549B</b>	<b>3549</b>	<b>V3549</b>	LTPP NPT 1-1/4	2.06	52,3	1.08	27,4

**PG** - for PG Thread Specifications, see page 3-49

PG 7	<b>3574B</b>	<b>3574</b>	-	LTPP PG 7	.63	16,0	.53	13,5
PG 9	<b>3575B</b>	<b>3575</b>	-	LTPP PG 9	.83	21,0		
PG 13.5	<b>3576B</b>	<b>3576</b>	-	LTPP PG 13.5	.98	24,9	.62	15,8
PG 21	<b>3401B</b>	<b>3401</b>	-	LTPP PG 21	1.29	32,8	.68	17,3
PG 29*	<b>3578B</b>	<b>3578</b>	-	LTPP PG 29	1.74	44,2	.87	22,1
PG 36*	<b>3579B</b>	<b>3579</b>	-	LTPP PG 36	2.06	52,3	.78	19,8

### Metric

M12	<b>3582B</b>	<b>3582</b>	-	LTPP M12	.63	16,0	.53	13,5
M16	<b>3583B</b>	<b>3583</b>	-	LTPP M16	.83	21,1		
M20	<b>3584B</b>	<b>3584</b>	-	LTPP M20	.98	24,9	.62	15,8
M32*	<b>3586B</b>	<b>3586</b>	-	LTPP M32	1.74	44,2	.87	22,1
M40*	<b>3587B</b>	<b>3587</b>	-	LTPP M40	2.06	52,3	.78	19,8

Standard color black. Consult Heyco for other colors.

\*Not cURus.

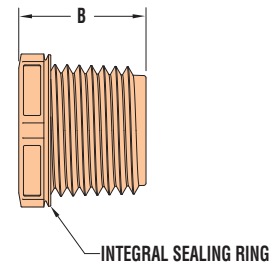
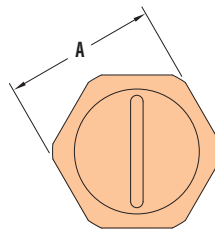

*Quick  
Specs*

Material	Nylon 6/6
Certifications	Recognized under the Component Program of Underwriters' Laboratories, File E330194 to both Canadian and U.S. Requirements
Flammability Rating	94V-2
Temperature Range	-40°F (-40°C) to 221°F (105°C)
IP Rating	IP 68 (70 PSI, 5 BAR)



Consult Heyco for Colors Other Than Black



## HEYCo-molded™ Liquid Tight Break-Thru Plugs

Mounting Hole Diameter Range: .500" (12,7 mm) to 1.500" (38,1 mm)\*

PANEL DIMENSIONS				CABLE DIAMETER RANGE		PART NO.	DESCRIPTION	PART DIMENSIONS			
Thickness at Locking Finger Steps		Mounting Hole Diameter*		in.	mm.			Black	A Head Diameter		B Overall Height
in.	mm.	in.	mm.							in.	mm.
For Panels up to .063" (1,6 mm) Thick											
.020	0,5	.500	12,7	.080 - .200	2,0 - 5,1	<b>C2008</b>	LTBP 500-063	.92	23,4	.32	8,1
.032	0,8	.625	15,9	.130 - .375	3,3 - 9,5	<b>C2012</b>	LTBP 625-063	1.03	26,2		
.040	1,0	.750	19,1	.175 - .400	4,4 - 10,2	<b>C2016</b>	LTBP 750-063	1.15	29,2		
.048	1,2	.875	22,2	.130 - .450	3,3 - 11,4	<b>C2020</b>	LTBP 875-063	1.28	32,5		
.063	1,6	1.000	25,4	.200 - .715	5,1 - 18,2	<b>C2022</b>	LTBP 1000-063	1.43	36,3		
		1.093	27,8	.250 - .765	6,4 - 19,4	<b>C2024</b>	LTBP 1093-063	1.53	38,9		
For Panels from .063" (1,6 mm) to .250" (6,4 mm) Thick											
.063	1,6	.500	12,7	.080 - .200	2,0 - 5,1	<b>C2058</b>	LTBP 500-250	.92	23,4	.63	15,9
.080	2,0	.625	15,9	.130 - .375	3,3 - 9,5	<b>C2062</b>	LTBP 625-250	1.03	26,2		
.094	2,4	.750	19,1	.175 - .400	4,4 - 10,2	<b>C2066</b>	LTBP 750-250	1.15	29,2		
.125	3,2	.875	22,2	.130 - .450	3,3 - 11,4	<b>C2070</b>	LTBP 875-250	1.28	32,5		
.157	4,0	1.000	25,4	.200 - .715	5,1 - 18,2	<b>C2072</b>	LTBP 1000-250	1.43	36,3		
.200	5,1	1.093	27,8	.250 - .765	6,4 - 19,4	<b>C2074</b>	LTBP 1093-250	1.53	38,9		
.250	6,4	1.375	34,9	.300 - .950	7,6 - 24,1	<b>C2080</b>	LTBP 1375-250	1.80	45,7	.67	17,0
		1.500	38,1	.375 - 1.060	9,5 - 26,9	<b>C2082</b>	LTBP 1500-250	1.93	49,0		

Standard color black. Consult Heyco for other colors.

\*Consult Heyco for other Mounting Hole Diameters. Our Axcell Rapid Response Team is ready to meet your requirements.

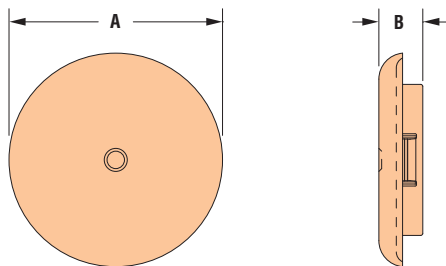

- These **co-molded** nylon and elastomer parts function as **Liquid Tight Plugs** with an IP 67/68 rating, yet can be pierced by **round wire, cable or tubing** to function as **Liquid Tight Bushings** with the same resulting IP 67/68 rating.
- **Certified by UL under UL 635**
- For use in panels as thin as .020" (0,5 mm) and as thick as .250" (6,4 mm).
- Provide liquid tight closure when used as a plug. When pierced, function as a liquid tight bushing that convert raw edged holes to smooth, neat, insulated holes.
- Used as a liquid tight bushing, HEYCo-molded Liquid Tight Break-Thru Plugs insulate and mechanically protect electrical and telecommunications cable, tubing, hose, rope, and utility lines.
- Locking fingers snap into holes with fingertip pressure.
- Locking fingers in fractional increments up to the maximum panel thickness.
- Withstand a push back force of greater than 35 pounds.
- Available in multiple sizes for use in .500" (12,7 mm) to 1.500" (38,1 mm) diameter holes.

Materials	Nylon 6/6 and TPE
Certifications	Recognized under the Component Program of Underwriters' Laboratories File E15331
Flammability Rating	HB
Temperature Range	-40°F (-40°C) to 212°F (100°C)
IP Rating	67/68

Quick Specs



## HEYCap™ D-Subminiature Protection Caps

- DSC Series Caps are designed to provide **electrostatic discharge protection** for rectangular D-subminiature input/output type connectors.
- Designed with an **integral flange** for easy application and removal.
- Fit over both **Standard Density** and **High Density** D-Sub Shells.
- Molded in pink dissipative ethylene vinyl acetate, which **meets the static decay requirements** of MIL-PRF-81705D: Surface resistivity less than  $1 \times 10^{12}$  ohms/sq.
- For similar schematic drawings see D-Subminiature Mounting Hole Plugs, see page 6-42.

Shell Designation & Type	SHELL DIMENSIONS				PART NO. Pink*	DESCRIPTION	PART DIMENSIONS								
	A		B				C		D		E		F		
	Width		Length				Head		Body						
	in.	mm.	in.	mm.			in.	mm.	in.	mm.	in.	mm.	in.	mm.	
1 or E	9 Socket	.31	7,9	.64	16,3	<b>G5160</b>	DSC 1S	.79	20,1	.45	11,4	.72	18,2	.38	9,5
	9 Pin	.33	8,4	.67	16,9	<b>G5161</b>	DSC 1P	.86	21,8	.51	12,9	.78	19,8	.43	10,9
2 or A	15 Socket	.31	7,9	.97	24,6	<b>G5162</b>	DSC 2S	1.10	27,9	.45	11,4	1.04	26,4	.38	9,5
	15 Pin	.33	8,4	.99	25,2	<b>G5163</b>	DSC 2P	1.19	30,2	.51	12,9	1.12	28,3	.43	10,9
3 or B	25 Socket	.33	7,9	1.51	38,3	<b>G5164</b>	DSC 3S	1.66	42,2	.46	11,7	1.12	28,3	.37	9,4
	25 Pin	.31	8,4	1.53	40,0	<b>G5165</b>	DSC 3P	1.70	43,2	.52	13,2	1.58	40,2	.43	11,0
4 or C	37 Socket	.31	7,9	2.16	54,8	<b>G5166</b>	DSC 4S	2.29	58,2	.45	11,4	1.61	41,0	.37	9,3
	37 Pin	.33	8,4	2.18	55,4	<b>G5167</b>	DSC 4P	2.37	60,2	.52	13,2	1.23	30,5	.45	11,4
5 or D	50 Socket	.42	10,7	2.06	52,4	<b>G5168</b>	DSC 5S	2.21	56,1	.56	14,2	2.15	54,5	.49	12,3
	50 Pin	.44	11,1	2.08	52,8	<b>G5169</b>	DSC 5P	2.27	57,6	.62	15,7	2.20	55,8	.55	14,0
6	104 Socket	.49	12,3	2.19	55,6	<b>G5170</b>	DSC 6S	2.35	59,7	.65	16,5	2.27	57,6	.56	14,3
	104 Pin	.50	12,8	2.21	56,2	<b>G5171</b>	DSC 6P	2.44	62,0	.70	17,8	2.29	58,2	.58	14,8

\* Material: Pink Static Dissipative Ethylene Vinyl Acetate (EVA). Black Conductive Polyethylene Copolymer also available, please consult Heyco.



## HEYCap™ Electro Miniature Protection Caps

- EMC Series Caps fit 36- and 68-pin Champ 050 series connectors and 50-pin Champ-type connectors.
- Designed with an **integral flange** for easy application and removal.
- Molded in pink dissipative ethylene vinyl acetate, which **meets the static decay requirements** of MIL-PRF-81705D: Surface resistivity less than  $1 \times 10^{12}$  ohms/sq.
- For similar schematic drawings see D-Subminiature Mounting Hole Plugs, see page 6-42.

Typical Configuration	SHELL DIMENSIONS				PART NO. Pink*	DESCRIPTION	PART DIMENSIONS							
	A		B				C		D		E		F	
	Width		Length				Head		Body					
	in.	mm.	in.	mm.			in.	mm.	in.	mm.	in.	mm.	in.	mm.
36 Pin	.25	6,4	1.05	26,7	<b>G5172</b>	EMC 36	1.18	30,0	.40	10,2	1.11	27,9	.31	7,9
50 Pin	.48	12,1	2.51	63,5	<b>G5173</b>	EMC 50	2.63	66,8	.60	15,2	2.57	65,1	.54	13,6
68 Pin	.26	6,6	1.83	46,5	<b>G5174</b>	EMC 68	1.95	49,5	.38	9,6	1.89	48,0	.32	8,1

\* Material: Pink Static Dissipative Ethylene Vinyl Acetate (EVA). Black Conductive Polyethylene Copolymer also available, please consult Heyco.

*Quick Specs*

Material: Pink Static Dissipative Ethylene Vinyl Acetate (EVA)  
 Temperature Range: -98°F (-68°C) to 140°F (60°C)



## Heyco® Nylon D-Subminiature Mounting Hole Plugs

Clearance Fit for Panel Thickness up to .170" (4,3 mm)

MOUNTING HOLE SIZE				PART NO.	DESCRIPTION	PART DIMENSIONS								
A		B				C	Head				Body			
in.	mm.	in.	mm.				in.	mm.	in.	mm.	in.	mm.	in.	mm.
.45	11,4	.81	20,6	<b>2966</b>	POP-DB9	1.25	31,8	.70	17,8	.69	17,5	.41	10,4	
		1.13	28,8	<b>2968</b>	POP-DB15	1.57	39,8	.70	17,8	1.05	26,7			
		1.67	42,5	<b>2970</b>	POP-DB25	2.12	51,0	.70	17,8	1.55	39,4			
		2.32	59,1	<b>2972</b>	POP-DB37	2.77	70,4	.70	17,8	2.23	56,6			

Standard color black. Consult Heyco for other colors.

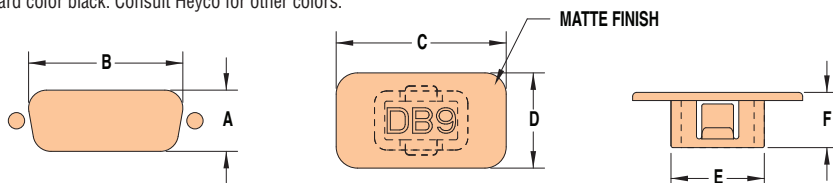

Material	Nylon 6/6
Certifications	Recognized under the Component Program of Underwriters' Laboratories, File E51579 Certified by Canadian Standards Association, File 8919
Flammability Rating	94V-2
Temperature Range	-40°F (-40°C) to 221°F (105°C)

- Fit standard D-Subminiature Cutouts.
- Provide aesthetic improvement for unused D-subminiature connector mounting holes.
- Suitable for use as dust protection for unused parallel and serial ports on computers and other electrical equipment.
- Cover unwanted holes in panel and are easily removable.
- Quick and easy installation with fingertip pressure.

Custom Color Match and Special Engraved Identification Available. Consult Heyco for Details

*Quick Specs*



## Heyco® IEC-14 Plug

For IEC-13 Female Connectors

PART NO. Black	DESCRIPTION	PART DIMENSIONS					
		A		B		C	
		in.	mm.	in.	mm.	in.	mm.
<b>G5365</b>	IECP C14	.96	24,4	.66	16,8	.38	9,7

Standard color black.

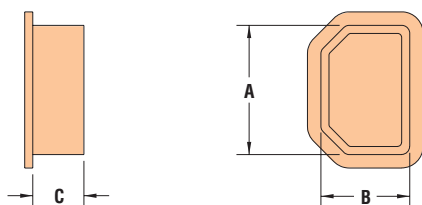

- These non-conductive plugs are used to **protect female IEC-13 connectors** during transit and storage.
- Will keep your connector **free of dust, moisture, and contaminants**.
- The flanged Plug head provides **ease of installation and removal**.
- Consult Heyco for the **IEC-20 Plug** (for IEC-19 female connectors).

Material	LDPE
Temperature Range	-94°F (-70°C) to 150°F (66°C)

*Quick Specs*



**USB-A Cap**

- Silicone material for high temperature applications up to 302°F (150°C).
- Protects adapter’s internal components with stress-free installation.

**USB-B Cap**

- Non-conductive, inexpensive, protects USB-B ports.
- Shields female ports from dust, moisture, and contaminants.
- USB-B plugs have a convenient pull-tab for quick and easy removal.
- Applicable Specs: USB-B MS-90376-Y, MS-25177, NAS-820, NAS-837

**Heyco® Connector Caps and Plugs**

PART NO. Black	DESCRIPTION	PART DIMENSIONS					
		A		B		C	
		in.	mm.	in.	mm.	in.	mm.
<b>USB Series</b>							
2960	USB-A Cap*	.48	12,2	.18	4,6	.44	11,1
2962	USB-B Plug	.36	9,0	.25	6,4	.25	6,4
<b>CP-RJ Series</b>							
2967	CP-RJ11	.41	10,4	.41	10,4	.33	8,4
2969	CP-RJ45	.49	12,4				

\*USB-A Cap color is red.

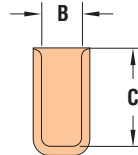
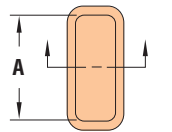

USB-A

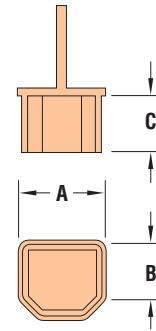

USB-B

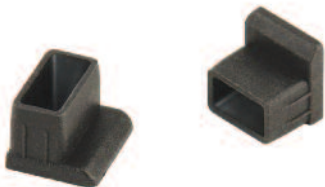

**CP-RJ Plugs**

- Silicone material for high temperature applications up to 302° F (150° C).
- Protects adapter’s internal components with stress-free installation.
- For Heyco Connector Port Plugs, **Part Nos. 3388 and 3389**, see page 6-34.

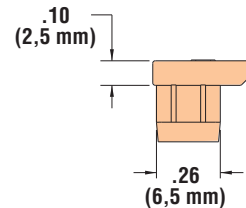
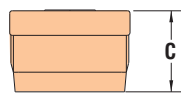
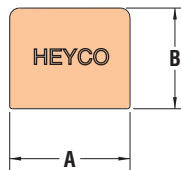

CP-RJ

*Quick Specs*

	USB-A	USB-B	CP-RJxx
Material	Vinyl	LDPE	Silicone Rubber
Fammability Rate	HB	HB	HB
Temperature Range	-26°F (-32°C) to 200°F (93°C)	0°F (-18°C) to 175°F (79°C)	-26°F (-32°C) to 400°F (204°C)



## Heyco® PG and Metric Threaded Plugs

Round Head with Slot

Plastic



THREAD TYPE/SIZE	PART NO.		DESCRIPTION	PART DIMENSIONS			
	Gray	Black		A Head Diameter		B Overall Height	
				in.	mm.	in.	mm.
<b>PG Threads - Polystyrene</b>							
PG 7	3405	3405B	TP PG 7	.59	15,0	.32	8,0
PG 9	3407	3407B	TP PG 9	.75	19,0	.37	9,5
PG 11	3402	3402B	TP PG 11	.87	22,0		
PG 13	3412	3412B	TP PG 13	.98	25,0	.39	10,0
PG 16	3414	3414B	TP PG 16	1.06	27,0		
PG 21	3416	3416B	TP PG 21	1.30	33,0		
PG 29	3418	3418B	TP PG 29	1.73	44,0	.47	12,0
PG 36	3415	3415B	TP PG 36	2.17	55,0	.55	14,0
PG 42	3400	3400B	TP PG 42	2.44	62,0		
PG 48	3417	3417B	TP PG 48	2.72	69,0	.63	16,0

NEW!

<b>Metric Threads - Nylon</b>							
THREAD TYPE/SIZE	PART NO.	DESCRIPTION	PART DIMENSIONS				
			A Head Diameter		B Overall Height		
			in.	mm.	in.	mm.	
M12 x 1,5	3403	3403B	TP M12	.59	15,0		
M16 x 1,5	3404	3404B	TP M16	.79	20,0	.41	10,5
M20 x 1,5	3406	3406B	TP M20	.95	24,0		
M25 x 1,5	3408	3408B	TP M25	1.18	30,0	.51	13,0
M32 x 1,5	3409	3409B	TP M32	1.48	37,0	.53	13,5
M40 x 1,5	3410	3410B	TP M40	1.81	46,0	.55	14,0
M50 x 1,5	3411	3411B	TP M50	2.20	56,0	.63	16,0
M63 x 1,5	3413	3413B	TP M63	2.76	70,0	.71	18,0

Standard color gray and black. Consult Heyco for other colors.

- Used to close **unnecessary PG and Metric threaded holes** when other threaded accessories may be added at a later time.
- Designed with slot for screwdriver installation
- For PG Threaded specifications, see page 3-53
- For Heyco Snap-In Metric Dome Plugs, see page 6-30.
- Nickel-Plated Brass Plugs are ideal where extra durability and strength are needed such as harsh environmental conditions.
- Nickel-Plated Brass Plugs include NBR O-ring

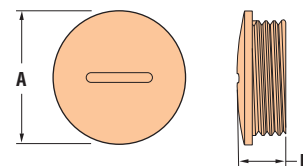

## Nickel-Plated Brass

ALL NEW PRODUCTS!

THREAD TYPE/SIZE	PART NO.	DESCRIPTION	PART DIMENSIONS			
			A Head Diameter		B Overall Height	
			in.	mm.	in.	mm.
<b>PG Threads</b>						
PG 7	13405	BRASS TP PG 7	.55	14,0	.31	8,0
PG 9	13407	BRASS TP PG 9	.67	17,0		
PG 11	13402	BRASS TP PG 11	.79	20,0	.35	9,0
PG 13	13412	BRASS TP PG 13	.87	22,0		
PG 16	13414	BRASS TP PG 16	.94	24,0	.37	9,5
PG 21	13416	BRASS TP PG 21	1.18	30,0	.43	11,0
PG 29	13418	BRASS TP PG 29	1.54	39,0	.47	12,0
PG 36	13415	BRASS TP PG 36	1.97	50,0	.59	15,0
PG 42	13400	BRASS TP PG 42	2.36	60,0		
PG 48	13417	BRASS TP PG 48	2.56	65,0	.63	16,0
<b>Metric Threads</b>						
M6 x1.0	13397	BRASS TP M6*	.35	9,0		
M8 x1.25	13398	BRASS TP M8*	.39	10,0		
M10 x1.5	13399	BRASS TP M10*	.47	12,0	.31	8,0
M12 x 1,5	13403	BRASS TP M12	.55	14,0		
M16 x 1,5	13404	BRASS TP M16	.75	19,0		
M20 x 1,5	13406	BRASS TP M20	.94	24,0	.35	9,0
M25 x 1,5	13408	BRASS TP M25	1.10	28,0	.43	11,0
M32 x 1,5	13409	BRASS TP M32	1.38	35,0	.47	12,0
M40 x 1,5	13410	BRASS TP M40	1.77	45,0	.55	14,0
M50 x 1,5	13411	BRASS TP M50	2.17	55,0	.59	15,0
M63 x 1,5	13413	BRASS TP M63	2.76	70,0	.63	16,0

\* Metric course-pitch threads

	Plastic TP Plugs	Brass TP Plugs
Material	Nylon 6/6 or Impact Resistant Polystyrene	Nickel-Plated Brass with an NBR O-ring
Flammability Rating	94V-2	
Temperature Range	-4° F (-20° C) to 176° F (80° C)	-40° F (-40° C) to 212° F (100° C)
IP Rating	IP 50	IP 68

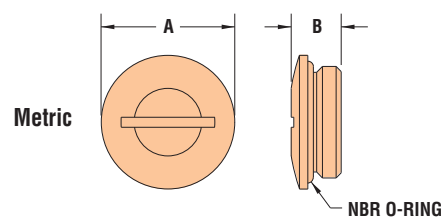
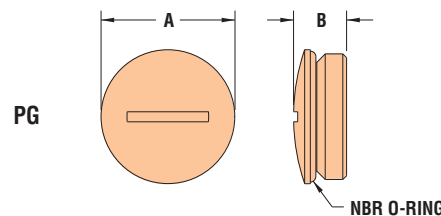

Quick Specs



**For NPS Threaded Ports**

- Provide a positive seal on NPS threaded ports.
- Flange compresses against the mounting hole surface area, keeping contaminants from the spot face.
- Round, 12-point “socket pattern” head.
- Integral, serrated Shoulder Washer.
- Applicable Specs. MIL-C-52078, MIL-C-5501/5, NAS 840.
- Red color.



**For SAE and ISO Threaded Ports**

- Provide a dual, positive seal on SAE and ISO straight-threaded ports.
- Integral Sealing Ring seats into the bevel of the threaded opening to prevent oil or fluid leakage.
- Lip on the flange compresses against the mounting hole surface, keeping contaminants from the spot face.
- Suitable for gasketing (optional).
- Slotted, 12-point head for screwdriver (SAE only), socket or wrench tightening.
- Round “socket pattern” Head.

**Heyco® Threaded Plugs for Straight Threaded Ports**  
 With Integral Sealing Ring **For SAE Threaded Ports** 12-Point Socket Head with Slot

THREADED PORT	PART NO.	DESCRIPTION	A 12-Point Socket Size*	PART DIMENSIONS					
				B Depth		C Head Height		D Shoulder Diameter	
				in.	mm.	in.	mm.	in.	mm.

**For NPS Threaded Ports - Red Color**

1/8	<b>G5410</b>	PNPS 1/8	9/16	.27	6,9	.31	7,9	.56	14,2
1/4	<b>G5411</b>	PNPS 1/4	9/16	.37	9,4	.31	7,9	.74	18,8
3/8	<b>G5412</b>	PNPS 3/8	9/16	.33	8,4	.38	9,7	.83	21,1
1/2	<b>G5413</b>	PNPS 1/2	9/16	.55	14,0	.37	9,4	1.04	26,4
3/4	<b>G5414</b>	PNPS 3/4	9/16	.63	16,0	.41	10,4	1.31	33,3

**For SAE Threaded Ports - Red Color - with Integral Sealing Ring\***

7/16-24	<b>G5420</b>	PSAE 7/16-24	3/8	.34	8,6	.26	6,6	.66	16,8
7/16-20	<b>G5421</b>	PSAE 7/16-20							
1/2-20	<b>G5422</b>	PSAE 1/2-20	7/16	.34	8,6	.30	7,6	.73	18,5
9/16-18	<b>G5423</b>	PSAE 9/16-18	1/2	.36	9,1	.30	7,6	.80	20,3
3/4-16	<b>G5424</b>	PSAE 3/4-16	11/16	.41	10,4	.31	7,9	1.02	25,9
7/8-14	<b>G5425</b>	PSAE 7/8-14	13/16	.53	13,5	.31	7,9	1.16	29,5
1-1/16-12	<b>G5426</b>	PSAE 1-1/16-12	1	.61	15,5	.31	7,9	1.45	36,8
1-5/16-12	<b>G5427</b>	PSAE 1-5/16-12	1-1/4	.61	15,5	.33	8,4	1.74	44,2
1-5/8-12	<b>G5428</b>	PSAE 1-5/8-12	1-9/16	.61	15,5	.33	8,4	2.17	55,1
1-7/8-12	<b>G5429</b>	PSAE 1-7/8-12	1-7/8	.62	15,7	.34	8,6	2.42	61,5

**For ISO Threaded Ports - Green Color - with Integral Sealing Ring**

10 x 1.5	<b>G5431</b>	PISO 10	10	.33	8,4	.33	8,4	.65	16,5
12 x 1.5	<b>G5432</b>	PISO 12	12	.41	10,4	.34	8,6	.73	18,5
14 x 1.5	<b>G5433</b>	PISO 14	12	.41	10,4	.38	9,7	.81	20,6
18 x 1.5	<b>G5434</b>	PISO 18	16	.41	10,4	.44	11,2	.97	24,6
22 x 1.5	<b>G5435</b>	PISO 22	20	.41	10,4	.44	11,2	1.12	28,4
27 x 2	<b>G5436</b>	PISO 27	24	.41	10,4	.44	11,2	1.36	34,5

\* SAE Threaded Ports feature a slotted Socket Head.

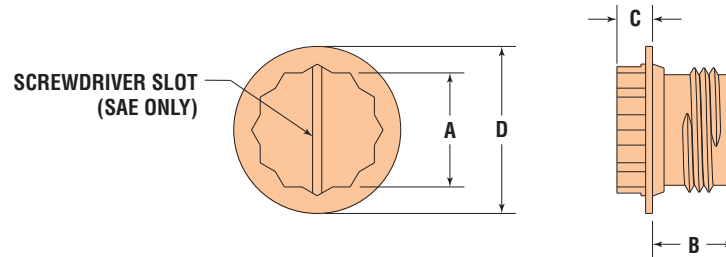

*Quick Specs*

Material Temperature Range	<b>PNPS &amp; PSAE</b> HDPE 0°F (-18°C) to 165°F (74°C)	Material Temperature Range	<b>PISO</b> Polypropylene -90°F (-70°C) to 250°F (121°C)





## Heyco® Push-In Threaded Plugs

For SAE and NPT Threaded Ports



- Offer the convenience of a push-in plug with the plugging quality of a threaded plug.
- Available with or without convenient Pull Tab for easy removal.

THREAD TYPE/SIZE		PART NO.	PART NO.	DESCRIPTION	PART DIMENSIONS					
SAE in.	NPT in.	Black No Tab	Black With Tab		A Head Diameter		B Overall Height		C Bottom Dia.	
					in.	mm.	in.	mm.	in.	mm.
1/4	-	9680	-	TP PI-250	.40	10,2	.25	6,4	.21	5,3
5/16	-	9681	-	TP PI-312	.52	13,2	.24	6,1	.25	6,4
3/8	1/8	9682	9682T	TP PI-375	.59	15,0	.24	6,1	.32	8,1
7/16	-	9683	9683T	TP PI-437	.64	16,3	.27	6,9	.37	9,4
1/2	1/4	9684	9684T	TP PI-500	.72	18,3	.27	6,9	.44	11,2
9/16	-	9685	-	TP PI-562	.81	20,6	.29	7,4	.50	12,7
5/8	3/8	9686	9686T	TP PI-625	.96	24,4	.29	7,4	.56	14,2
3/4	-	9687	9687T	TP PI-750	.95	24,1	.29	7,4	.68	17,3
7/8	-	9688	9688T	TP PI-875	1.15	29,2	.29	7,4	.80	20,3

Standard color black.

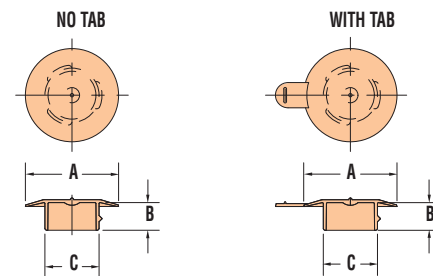

## Heyco® TEMPlugs™

For NPT Threaded Ports

Temporary Threaded Plugs for In-House Pressure Testing, Handling, and Transport



- Not intended for permanent applications; commonly used for low-pressure testing and in-plant processing.
- Keep contaminants and moisture from threaded ports.
- Oil and heat resistant up to 250°F.
- Applicable Spec: MIL-C-5501/5, NAS 840.

NPT THREADED PORT SIZE	PART NO.  Black	DESCRIPTION	PART DIMENSIONS							
			A Wrenching Flats		B Threaded Section		C Head Height		D Flange Diameter	
			in.	mm.	in.	mm.	in.	mm.	in.	mm.

### Square Head - with Flange

1/8	G5440	PTNS 1/8-F	.43	10,9	.29	7,4	.19	4,8	.56	14,2
1/4	G5441	PTNS 1/4-F	.44	11,2	.35	9,0	.25	6,4	.69	17,5
3/8	G5442	PTNS 3/8-F	.44	11,2	.41	10,4	.25	6,4	.81	20,6
1/2	G5443	PTNS 1/2-F	.56	14,2	.47	11,9	.25	6,4	1.00	25,4
3/4	G5444	PTNS 3/4-F	.63	16,0	.52	13,2	.25	6,4	1.25	31,8

### Square Head - no Flange

3/4	G5449	PTNS 3/4	.62	15,7	.52	13,2				
1	G5450	PTNS 1	.81	20,6	.59	15,0	.25	6,4	n/a	n/a
1-1/4	G5451	PTNS 1-1/4	1.00	25,4	.83	21,1	.38	9,7		
1-1/2	G5452	PTNS 1-1/2	1.25	31,8						

### Hex Head

1/4	G5455	PTNH 1/4	.25	6,4	.31	7,9				
3/8	G5456	PTNH 3/8	.31	7,9	.38	9,7				
1/2	G5457	PTNH 1/2	.38	9,7						
3/4	G5458	PTNH 3/4	.56	14,2	.50	12,7				
1	G5459	PTNH 1	.63	16,0	.53	13,5				

Standard color black.

Material	EVA Ethylene Vinyl Acetate (part nos. 9680 & 9681) LDPE Low Density Polyethylene (part nos. 9682 thru 9688T) HDPE High-Density Polyethylene (TEMPlugs)
Temperature Range	EVA -98°F (-68°C) to 140°F (60°C) LDPE -94°F (-70°C) to 150°F (66°C) HDPE 0°F (-18°C) to 165°F (74°C)

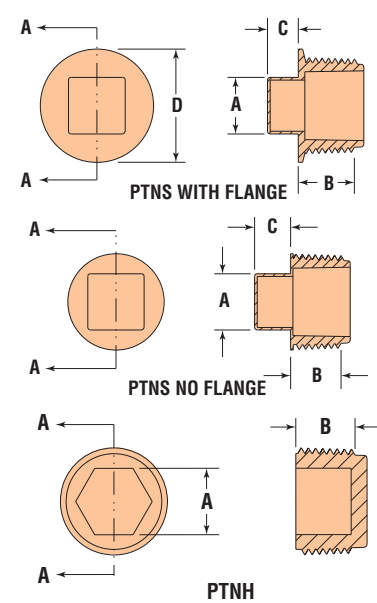



## HEYCap™ Tapered Caps and Plugs–NPT

For NPT Fitting Hubs and Threaded Mounting Holes

- HEYCaps can be used as either **caps or plugs**.
- Because they are tapered in design and made from highly flexible polyethylene, they not only **fit snugly** but are readily **removable**.
- Applicable Specs: MIL-C-5501/7 (MIL-C-52078), NAS-835.

**CAPS:**

- Especially recommended for use on **threaded external NPT fitting hubs**.
- Part dimensions are based on average threaded hub fit. Before ordering in quantity, please sample HEYCaps.
- Recommended Closures: Threaded hubs where Cap dimension B is at least 1% smaller than the hub to be capped. Minimum .020" (0,5 mm).

**PLUGS:**

- Especially recommended for use on **threaded internal NPT fittings and mounting holes**.
- Part dimensions are based on average tapped hole fit. Before ordering in quantity, please sample HEYCap Tapered Plugs.
- Recommended Closures: Threaded mounting holes where Plug dimension A is at least 1% larger than the hole to be plugged. Minimum .020" (0,5 mm).

Fits this NPT Hub or Mounting Hole	PART NO. Red	DESCRIPTION	PART DIMENSIONS							
			A - Major Body Diameters		B - Minor		C Head Diameter		D Depth	
			in.	mm.	in.	mm.	in.	mm.	in.	mm.

**HEYCap Tapered Caps\* for NPT Fitting Hubs - Body Diameters reference Inside**

1/8	<b>G5014</b>	TCP 49-42†	.42	10,7	.36	9,0	.63	16,0	.38	9,7
1/4	<b>G5020</b>	TCP 61-55	.55	13,8	.47	11,9	.75	19,1	.44	11,2
3/8	<b>G5027</b>	TCP 76-69	.69	17,6	.61	15,6	.88	22,4	.50	12,7
1/2	<b>G5035</b>	TCP 91-85	.85	21,6	.74	18,8	1.06	26,9	.63	16,0
3/4	<b>G5047</b>	TCP 115-108	1.08	27,5	.93	23,7	1.31	33,3	.75	19,1
1	<b>G5057</b>	TCP 136-130	1.30	33,0	1.17	29,8	1.50	38,1	.81	20,6
1-1/4	<b>G5071</b>	TCP 168-162	1.62	41,1	1.50	38,0	1.88	47,8	.75	19,1
1-1/2	<b>G5080</b>	TCP 195-189	1.89	48,0	1.72	43,6	2.13	54,1		
2	<b>G5096</b>	TCP 246-240	2.40	61,0	2.24	56,8	2.63	66,8	1.00	25,4
2-1/2	<b>G5110</b>	TCP 299-295	2.95	74,9	2.69	68,2	3.13	79,5		
3	<b>G5116</b>	TCP 356-349	3.49	88,7	3.20	81,3	3.69	93,7	1.13	28,7

**HEYCap Tapered Plugs\*\* for NPT Threaded Mounting Holes - Body Diameters reference Outside**

1/8	<b>G5011</b>	TCP 40-33	.40	10,1	.33	8,4	.53	13,5	.38	9,7
1/4	<b>G5014</b>	TCP 49-42†	.49	12,4	.42	10,7	.63	16,0		
3/8	<b>G5022</b>	TCP 63-57	.63	16,0	.55	14,0	.75	19,1	.47	11,9
1/2	<b>G5029</b>	TCP 79-73	.79	20,1	.69	17,5	.94	23,9	.56	14,2
3/4	<b>G5040</b>	TCP 104-98	1.04	26,4	.92	23,4	1.16	29,5	.69	17,5
1	<b>G5048</b>	TCP 122-115	1.22	31,0	1.09	27,7	1.41	35,8	.75	19,1
1-1/4	<b>G5068</b>	TCP 160-154	1.60	40,6	1.51	38,4	1.75	44,5	.50	12,7
1-1/2	<b>G5075</b>	TCP 181-175	1.81	46,0	1.78	45,2	2.00	50,8	.38	9,7
2	<b>G5090</b>	TCP 226-220	2.26	57,4	2.23	56,6	2.50	63,5	.50	12,7
2-1/2	<b>G5106</b>	TCP 279-273	2.79	70,9	2.64	67,1	2.94	74,7		
3	<b>G5115</b>	TCP 346-338	3.46	87,9	3.33	84,6	3.63	92,2	.75	19,1

\*May also be used as Plugs: to determine Outside Diameters, add approximately .06" (1,5 mm) to Inside Diameter dimensions.

\*\*May also be used as Caps: to determine Inside Diameters, subtract approximately .06" (1,5 mm) from Outside Diameter dimensions.

†Part No. **G5014** functions as a Cap for NPT 1/8" Hubs and a Plug for NPT 1/4" Hubs. Standard color red.



TAPERED CAP

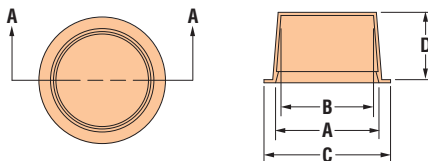

TAPERED PLUG

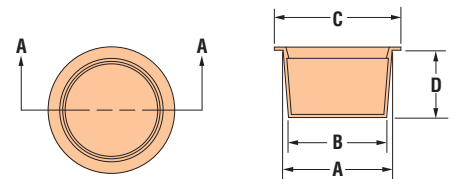

*Quick Specs*

Material	LDPE Standard Color: Red
Temperature Range	-94°F (-70°C) to 150°F (66°C)



## HEYCap™ Tapered Caps and Plugs—SAE

For SAE Fitting Hubs and Threaded Mounting Holes

Fits this SAE Hub or Mounting Hole	PART NO. Red	DESCRIPTION	PART DIMENSIONS							
			A - Major Body Diameters				C Head Diameter		D Depth	
			in.	mm.	in.	mm.	in.	mm.	in.	mm.

**HEYCap Tapered Caps\*** for SAE Fitting Hubs - Body Diameters reference Inside

1/8	<b>G5009</b>	TCP 37-30†	.30	7,7	.24	6,0	.50	12,7		
3/16	<b>G5013</b>	TCP 46-39	.39	10,0	.33	8,3	.59	15,0	.38	9,7
1/4	<b>G5015</b>	TCP 51-45	.45	11,5	.39	9,8	.66	16,8		
5/16	<b>G5022</b>	TCP 63-57	.57	14,4	.49	12,4	.75	19,1	.47	11,9
3/8	<b>G5023</b>	TCP 67-61	.61	15,4	.52	13,2	.81	20,6	.50	12,7
1/2	<b>G5031</b>	TCP 82-76	.76	19,3	.66	16,8	.97	24,6	.57	14,2
5/8	<b>G5036</b>	TCP 93-87	.87	22,0	.75	19,1	1.09	27,7	.63	16,0
3/4	<b>G5047</b>	TCP 115-108	1.08	27,5	.93	23,7	1.31	33,3	.75	19,1
1	<b>G5057</b>	TCP 136-130	1.30	33,0	1.17	29,8	1.50	38,1	.81	20,6
1-1/4	<b>G5071</b>	TCP 168-162	1.62	41,1	1.50	38,0	1.88	47,8	.75	19,1
1-1/2	<b>G5080</b>	TCP 195-189	1.89	48,0	1.72	43,6	2.13	54,1	1.00	25,4
1-3/4	<b>G5092</b>	TCP 231-225	2.25	57,2	2.07	52,7	2.56	65,0		
2	<b>G5097</b>	TCP 260-254	2.54	64,5	2.33	59,3	2.81	71,4	1.03	26,2

**HEYCap Tapered Plugs\*\*** for SAE Threaded Mounting Holes - Body Diameters reference Outside

1/8	<b>G5007</b>	TCP 30-24	.30	7,7	.24	6,0	.44	11,2		
3/16	<b>G5009</b>	TCP 37-30†	.37	9,3	.30	7,6	.50	12,7		
1/4	<b>G5012</b>	TCP 43-37	.43	10,8	.36	9,2	.56	14,2	.38	9,7
5/16	<b>G5014</b>	TCP 49-42	.49	12,3	.42	10,6	.63	16,0		
3/8††	<b>G5016</b>	TCP 55-49	.55	13,9	.47	12,0	.69	17,5	.44	11,2
	<b>G5020</b>	TCP 61-55	.61	15,4	.53	13,5	.75	19,1		
1/2	<b>G5026</b>	TCP 73-66	.73	18,5	.64	16,3	.88	22,4	.50	12,7
5/8	<b>G5033</b>	TCP 85-79	.85	21,5	.75	19,1	1.00	25,9	.56	9,9
3/4	<b>G5040</b>	TCP 104-98	1.04	26,4	.92	23,2	1.16	29,5	.69	17,5
1	<b>G5049</b>	TCP 128-122	1.28	32,6	1.18	29,8	1.44	36,6	.63	16,0
1-1/4	<b>G5068</b>	TCP 160-154	1.60	40,6	1.51	38,4	1.75	44,5	.50	12,7
1-1/2	<b>G5077</b>	TCP 188-182	1.88	47,8	1.75	44,5	2.00	50,8	.75	19,1
1-3/4	<b>G5089</b>	TCP 224-218	2.24	57,0	2.07	52,5	2.44	62,0	1.00	25,4
2	<b>G5096</b>	TCP 246-240	2.46	62,6	2.30	58,4	2.63	66,8	1.00	25,4

\*May also be used as Plugs: to determine Outside Diameters, add approximately .06" (1,5 mm) to Inside Diameter dimensions.

\*\*May also be used as Caps: to determine Inside Diameters, subtract approximately .06" (1,5mm) from Outside Diameter dimensions.

†Part No. **G5009** functions as a Cap for SAE 1/8" Hubs and a Plug for SAE 3/16" Hubs.

††Use Part No. **G5016** for SAE 9/16-18 thread and Part No. **G5020** for SAE 5/8-18 thread Standard color red.

- HEYCaps can be used as either **caps or plugs**.
- Because they are tapered in design and made from highly flexible polyethylene, they not only **fit snugly** but are readily **removable**.
- Applicable Specs: MIL-C-5501/7 (MIL-C-52078), NAS-835.

**CAPS:**

- Especially recommended for use on **threaded external SAE and MIL Std.-type** tube and hydraulic fittings.
- Part dimensions are based on average threaded hub fit. Before ordering in quantity, please sample HEYCaps.
- Recommended Closures: Threaded hubs where Cap dimension B is at least 1% smaller than the hub to be capped. Minimum .020" (0,5 mm).

**PLUGS:**

- Especially recommended for use on **threaded internal SAE and MIL Std.-type** tube and hydraulic fittings.
- Part dimensions are based on average tapped hole fit. Before ordering in quantity, please sample HEYCap Tapered Plugs.
- Recommended Closures: Threaded mounting holes where Plug dimension A is at least 1% larger than the hole to be plugged. Minimum .020" (0,5 mm).
- See schematic on page 6-47.



Material LDPE  
Standard Color: Red  
Temperature Range -94°F (-70°C) to 150°F (66°C)

Quick Specs



- Close unneeded sheet metal panel holes in equipment such as automobile bodies, tanks, refrigeration units, etc.
- Recessed button head style (SMP R).
- Flush button head style (SMP F).
- Retaining bead snaps easily into place.
- For easier to install Sheet Metal Plugs made from flexible Santoprene, see Heyco Metric Ergonomic Plugs on page 6-33.

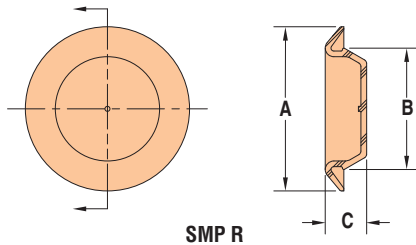

SMP R

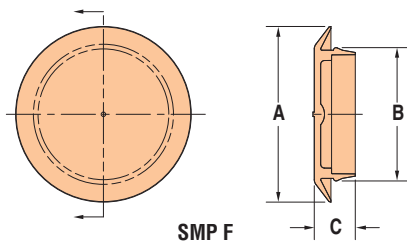

SMP F

## Heyco® LDPE Sheet Metal Plugs

For Panel Thicknesses from .02" (0,5 mm) to .18" (4,6 mm)

Mounting Hole Diameter Range: .18" (4,6 mm) to 3.00" (76,2 mm)

PANEL DIMENSIONS				PART NO.	DESCRIPTION	PART DIMENSIONS					
Thickness Range		Mounting Hole Diameter Range				Black	A		B		C
in.	mm.	in.	mm.		Head Diameter in.		Head Diameter mm.	Bottom Diameter in.	Bottom Diameter mm.	Overall Height in.	Overall Height mm.
<b>Recessed Head - for Panel Thicknesses from .02" (0,5 mm) to .18" (4,6 mm)</b>											
.02-.10	0,51-2,54	.37-.39	9,4-9,9	9610	SMP R-375	.75	19,1	.41	10,4	.31	7,9
.02-.07	0,51-1,78	.50-.52	12,7-13,2	9611	SMP R-500	.85	21,6	.55	14,0	.29	7,4
.02-.14	0,51-3,56	.73-.76	18,5-19,3	9614	SMP R-750	1.16	29,5	.79	20,1	.34	8,6
.02-.07	0,51-1,78	.79-.82	20,1-20,8	9615	SMP R-812	1.15	29,2	.85	21,6	.29	7,4
.02-.10	0,51-2,54	.87-.90	22,1-22,9	9616	SMP R-875	1.23	31,2	.93	23,6	.35	8,9
		.99-1.02	25,2-25,9	9618	SMP R-1000	1.35	34,3	1.05	26,7		
		1.04-1.07	26,4-27,2	9619	SMP R-1062	1.40	35,6	1.10	27,9		
		1.09-1.12	27,7-28,5	9620	SMP R-1093	1.47	37,3	1.16	29,5		
.02-.18	0,51-4,57	1.10-1.15	27,9-29,2	9621	SMP R-1125	1.53	38,9	1.18	30,0	.43	10,9
.01-.10	0,25-2,54	1.23-1.27	31,2-32,3	9622	SMP R-1250	1.60	40,6	1.30	33,0	.35	8,9
		1.30-1.34	33,0-34,0	9623	SMP R-1312	1.67	42,4	1.36	34,5		
.02-.10	0,51-2,54	1.36-1.40	34,6-35,6	9624	SMP R-1375	1.73	43,9	1.43	36,3	.36	9,1
		1.48-1.52	37,6-38,6	9625	SMP R-1500	1.85	47,0	1.55	39,4		
.03-.10	0,76-2,54	1.59-1.65	40,4-41,9	9627	SMP R-1625	2.00	50,8	1.68	42,7	.36	9,1
.02-.10	0,51-2,54	1.75	44,5	9628	SMP R-1750	2.13	54,1	1.80	45,7	.35	8,9
		1.85-1.90	47,0-48,3	9631	SMP R-1875	2.24	56,9	1.93	49,0		
.02-.10	0,51-2,54	1.97-2.02	50,0-51,3	9632	SMP R-2000	2.35	59,7	2.05	52,1	.36	9,1
		2.50	63,5	9633	SMP R-2.5	3.00	76,2	2.57	65,3		
		3.00	76,2	9635	SMP R-3.0	3.56	90,4	3.06	77,7		

### Flush Head - for Panel Thicknesses from .02" (0,5 mm) to .11" (2,8 mm)

.02-.04	0,51-1,02	.18-.19	4,6-4,9	9640	SMP F-M5*	.39	9,9	.21	5,3	.21	5,3
.02-.06	0,51-1,52	.23-.24	5,8-6,1	9641	SMP F-M6*	.50	12,7	.29	7,4	.45	11,4
.02-.07	0,51-1,78	.24-.25	6,1-6,4	9642	SMP F-250*	.50	12,7	.28	7,1	.21	5,3
.02-.05	0,51-1,27	.37-.38	9,4-9,7	9644	SMP F-375	.75	19,1	.41	10,4	.19	4,8
.03-.06	0,76-1,52	.43-.45	10,9-11,4	9646	SMP F-437	.69	17,5	.47	11,9	.22	5,6
.03-.08	0,76-2,03	.49-.51	12,5-13,0	9647	SMP F-500	.86	21,8	.54	13,7	.25	6,4
		.55-.56	14,0-14,2	9648	SMP F-562	.87	22,1	.60	15,2		
.06-.08	1,52-2,03	.62	15,7	9649	SMP F-625	.81	20,6	.67	17,0	.29	7,4
.03-.08	0,76-2,03	.68-.70	17,3-17,8	9650	SMP F-687	1.01	25,7	.73	18,5		
.05-.11	1,27-2,79	.73-.76	18,5-19,3	9651	SMP F-750	1.01	25,7	.79	20,1	.25	6,4
.03-.08	0,76-2,03	.86-.88	21,8-22,4	9654	SMP F-875	1.16	29,5	.91	23,1		
		.92-.95	23,4-24,1	9656	SMP F-937	1.31	33,3	.98	24,9		
		1.00	25,4	9657	SMP F-1000	1.38	35,1	1.04	26,4		
.02-.18	0,51-4,57	1.10-1.15	27,9-29,2	9660	SMP F-1125	1.53	38,9	1.18	30,0	.43	10,9
.03-.08	0,76-2,03	1.16-1.20	29,5-30,5	9661	SMP F-1187	1.56	39,6	1.22	31,0	.25	6,4
		1.25	31,8	9663	SMP F-1250	1.62	41,1	1.29	32,8		
		1.29-1.33	32,8-33,8	9664	SMP F-1312	1.68	42,7	1.36	34,6		
		1.50	38,1	9665	SMP F-1500	1.88	47,8	1.54	39,1		
		1.75	44,5	9666	SMP F-1750	2.12	53,8	1.79	45,5		
		1.98-2.01	50,3-51,1	9667	SMP F-2000	2.36	59,9	2.04	51,8		
		2.50	63,5	9669	SMP F-2.5	3.00	76,2	2.56	65,0		
3.00	76,2	9671	SMP F-3.0	3.36	85,3	3.06	77,7				

Standard color black.

\* Molded from EVA.

Quick Specs

Material	EVA* and LDPE
Temperature Range	-98°F (-68°C) to 140°F (60°C) (EVA) -94°F (-70°C) to 150°F (66°C) (LDPE)



# HEYCaps™ and Plugs for Round Tubing



## CRT Series - Clearance Fit

TUBE A Outside Dia.		PART NO. Black	DESCRIPTION	HEYCap B Height	
in.	mm.			in.	mm.
<b>Standard Duty</b>					
.25	6,4	G5200	CRT 25	.46	11,7
.38	9,5	G5201	CRT 38		
.50	12,7	G5202	CRT 50	.59	15,0
.63	15,9	G5203	CRT 63		
.75	19,1	G5204	CRT 75	.71	18,0
.88	22,2	G5205	CRT 88		
1.00	25,4	G5207	CRT 100	.85	21,6
1.13	28,6	G5208	CRT 113		
1.25	31,8	G5209	CRT 125	.98	24,9
1.50	38,1	G5210	CRT 150		
1.75	44,5	G5211	CRT 175	1.10	27,9
<b>Heavy Duty</b>					
Depth					
.75	19,1	G5212	CRT 75H	.50	12,7
.88	22,2	G5213	CRT 88H		
1.00	25,4	G5214	CRT 100H	.62	15,8
1.13	28,6	G5215	CRT 113H		
1.25	31,8	G5216	CRT 125H		

Standard color black.

## PRT Series - Ribbed Fit

TUBE DIMENSIONS					PART NO. Black	DESCRIPTION	PART DIMENSIONS			
Inside Diameter Range		Typical Gauge	A Outside Diameter				B Depth		in.	mm.
Minimum in.	Maximum mm.		in.	mm.			in.	mm.		
.31	7,9	.33	8,4	13 - 14	G5220	PRT 50-13	.50	12,7	.45	11,4
.37	9,4	.43	10,9	16 - 20	G5221	PRT 50-16	.63	15,9	.44	11,2
.46	11,7	.56	14,2	14 - 20	G5223	PRT 63-14				
.58	14,7	.68	17,3	14 - 20	G5224	PRT 75-14	.75	19,1	.44	11,2
.61	15,5	.71	18,1	10 - 14	G5225	PRT 88-10				
.71	18,0	.91	23,1	14 - 20	G5226	PRT 88-14	.88	22,2	.52	13,2
.73	18,5	.83	21,1	10 - 14	G5227	PRT 100-10				
.83	21,0	.93	23,6	14 - 20	G5228	PRT 100-14	1.00	25,4	.50	12,7
.96	23,4	1.06	26,9	14 - 20	G5229	PRT 113-14				
.98	24,9	1.08	27,4	10 - 14	G5230	PRT 125-10	1.25	31,8	.59	15,0
1.08	27,4	1.18	30,0	14 - 20	G5231	PRT 125-14				
1.21	30,7	1.31	33,3	14 - 20	G5232	PRT 138-14	1.34	34,9	.67	17,0
1.17	29,7	1.28	32,5	8 - 12	G5233	PRT 150-08				
1.23	21,2	1.33	33,8	10 - 14	G5234	PRT 150-10	1.50	38,1	.66	16,8
1.33	33,8	1.43	36,3	14 - 20	G5235	PRT 150-14				
1.36	34,5	1.46	37,1	10 - 14	G5236	PRT 163-10	1.63	41,3	.69	17,5
1.46	37,0	1.56	39,6	14 - 20	G5237	PRT 163-14				
1.48	37,6	1.58	40,1	10 - 14	G5238	PRT 175-10	1.75	44,5	.66	16,8
1.58	40,1	1.68	42,7	14 - 20	G5239	PRT 175-14				
1.73	43,9	1.83	46,5	10 - 14	G5241	PRT 200-10	1.95	49,5	.66	16,8
1.83	46,5	1.93	49,0	14 - 20	G5242	PRT 200-14				
1.86	47,2	2.00	50,8	10 - 14	G5243	PRT 213-10	2.13	54,0	.66	16,8
1.98	50,3	2.08	52,8	10 - 14	G5244	PRT 225-10				
2.08	52,8	2.18	53,4	14 - 20	G5245	PRT 225-14	2.25	57,2	.66	16,8
2.11	53,6	2.21	56,1	10 - 14	G5246	PRT 238-10				
2.17	55,1	2.28	57,9	8 - 12	G5247	PRT 250-08	2.50	63,5	.69	17,5
2.43	61,7	2.47	62,7	14 - 20	G5248	PRT 250-14				

Standard color black.

Material	LDPE
Temperature Range	-94°F (-70°C) to 150°F (66°C)

### Standard Duty

- HEYCaps Series CRT Caps for Round Tubing make **economical, attractive glides** for household and patio furniture; office tables, chairs and equipment; utility carts and exercise equipment.
- As **finishing caps** for both tubing and rods, they cover any scratches, burrs or distortions that may result from cutting operations.
- Provide protection against injury from sharp rod and tubing edges.
- See pages 6-51 and 6-52 for Heyco Plugs for Square and Rectangular Tubing.

### Heavy Duty

- Heavy Duty Caps **finish the ends of round tubing** on numerous products such as furniture, lawn and garden equipment, tools and appliances.
- Thick wall construction** makes them ideal for threaded connections where extra protection is required.
- Designed for **easy installation**.
- Seat with a firm grip** that prevents accidental removal.

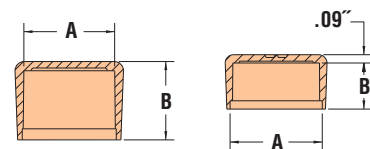

STANDARD DUTY

HEAVY DUTY

- With durable construction and **excellent gliding edges**, Heyco PRT Series Plugs for Round Tubing may be used on a wide range of metal furniture, appliances, and similar items.
- Tapered rib design** ensures a secure fit.
- A **thick, impact and abrasion resistant base** makes PNT Series Plugs ideal tubing closures for products subject to heavy-duty service or exposure to adverse environments.
- Not subject to rust or corrosion.
- For larger diameter sizes, please consult Heyco.

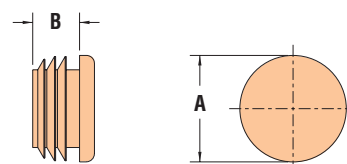



- Heyco Series PST Plugs for Square Tubing **finish raw tubing ends** with a clean finish.
- Sized for different gauges, **fit flush with tubing sides.**
- **Keep dirt and moisture out** of sensitive areas.
- All PST Series Plugs are **.50" (12,7 mm) in depth.**
- **Protect against injury** from sharp tubing edges.
- See page 6-50 for HEYCaps and Plugs for Round Tubing
- See page 6-52 for Heyco Plugs for Rectangular Tubing.

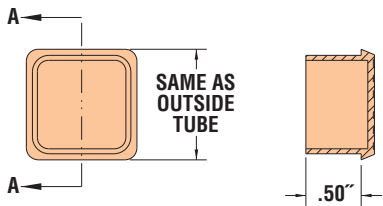

## Heyco® Plugs for Square Tubing

### PST Series - Clearance Fit

TUBE DIMENSIONS				Typical Gauge	PART NO. Black	DESCRIPTION
Outside Dimension		Inside Dimension				
in.	mm.	in.	mm.			
.50	12,7	.37	9,4	16	<b>G5260</b>	PST 50-16
.75	19,1	.62	15,7	16	<b>G5261</b>	PST 75-16
1.00	25,4	.76	19,3	11	<b>G5262</b>	PST 100-11
		.83	21,1	14	<b>G5263</b>	PST 100-14
		.87	22,1	16	<b>G5264</b>	PST 100-16
		.90	22,9	18	<b>G5265</b>	PST 100-18
1.25	31,8	.93	23,6	20	<b>G5266</b>	PST 100-20
		1.01	25,7	11	<b>G5267</b>	PST 125-11
		1.08	27,4	14	<b>G5268</b>	PST 125-14
1.50	38,1	1.12	28,4	16	<b>G5269</b>	PST 125-16
		1.26	32,0	11	<b>G5270</b>	PST 150-11
		1.33	33,9	14	<b>G5271</b>	PST 150-14
2.00	50,8	1.37	34,8	16	<b>G5272</b>	PST 150-16
		1.76	44,7	11	<b>G5273</b>	PST 200-11
		1.83	46,6	14	<b>G5274</b>	PST 200-14
		1.87	47,5	16	<b>G5275</b>	PST 200-16

Standard color black.

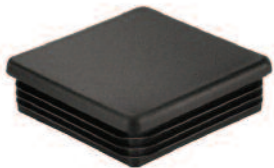

- Heyco PSTR Series Plugs feature **externally tapered ribs** designed to fit a wide range of tubing gauges while accommodating any dimensional fluctuations within the tubing.
- Exterior ribs provide a **sure grip inside the tubing**, without the unsightly plastic shavings found on many straight wall glide installations.
- Not subject to rust or corrosion.
- For larger sizes, please consult Heyco.

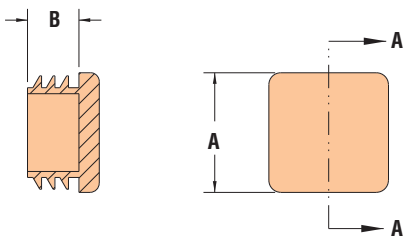

### PSTR Series - Ribbed Fit

TUBE DIMENSIONS					PART NO. Black	DESCRIPTION	PART DIMENSIONS			
Inside Dimension Range		Typical Gauge	A Outside Dimension				B Depth			
Minimum in.	Maximum mm.		in.	mm.	in.	mm.	in.	mm.		
.37	9,4	.40	10,2	16 - 18	<b>G5280</b>	PST R-50-16	.50	12,7	.44	11,2
.46	11,8	.56	14,2	14 - 20	<b>G5281</b>	PST R-63-14	.63	15,9	.43	10,9
.48	12,2	.58	14,8	10 - 14	<b>G5282</b>	PST R-75-10	.75	19,1		
.58	14,8	.68	17,3	14 - 20	<b>G5283</b>	PST R-75-14				
.71	18,1	.81	20,6	14 - 20	<b>G5284</b>	PST R-88-14	.88	22,2		
.73	18,6	.83	21,2	10 - 14	<b>G5285</b>	PST R-100-10	1.00	25,4	.49	12,4
.83	21,2	.93	23,6	14 - 20	<b>G5287</b>	PST R-100-14				
.96	24,5	1.06	26,9	14 - 20	<b>G5289</b>	PST R-113-14	1.13	28,6		
.98	24,9	1.08	27,5	10 - 14	<b>G5290</b>	PST R-120-10	1.25	31,8		
1.08	27,5	1.18	30,0	14 - 20	<b>G5291</b>	PST R-120-14				
1.11	28,2	1.21	30,8	10 - 14	<b>G5292</b>	PST R-138-10	1.38	34,9	.52	13,2
1.21	30,8	1.31	33,3	14 - 20	<b>G5293</b>	PST R-138-14				
1.23	31,3	1.33	33,9	10 - 14	<b>G5294</b>	PST R-150-10	1.50	38,1		
1.33	33,9	1.43	36,3	14 - 20	<b>G5295</b>	PST R-150-14				
1.48	37,6	1.58	40,2	10 - 14	<b>G5296</b>	PST R-170-10	1.75	44,5		
1.58	40,2	1.68	42,7	14 - 20	<b>G5297</b>	PST R-170-14				
1.52	38,7	1.67	42,4	4 - 8	<b>G5298</b>	PST R-200-04	2.00	50,8	.56	14,2
1.73	44,0	1.83	46,6	10 - 14	<b>G5299</b>	PST R-200-10				
1.83	46,6	1.93	49,0	14 - 20	<b>G5300</b>	PST R-200-14	2.25	57,2		
1.98	50,3	2.08	52,9	10 - 14	<b>G5301</b>	PST R-225-10				
2.09	53,2	2.23	56,7	6 - 10	<b>G5302</b>	PST R-250-06	2.50	63,5	.56	14,2
2.23	56,7	2.33	59,3	10 - 14	<b>G5303</b>	PST R-250-10	2.50	63,5	.50	12,7
2.37	60,2	2.45	62,2	16 - 23	<b>G5304</b>	PST R-250-16	2.50	63,5	.56	14,2

Standard color black.

Material LDPE  
 Temperature Range -94°F (-70°C) to 150°F (66°C)



## Heyco® Ergonomic Plugs for Square Tubing

### PSTE Series - Vinyl for Greater Flexibility

TUBE DIMENSIONS Inside					PART NO.	DESCRIPTION	PART DIMENSIONS			
Dimension Range		Typical Gauge	A				B			
Minimum	Maximum		Outside Dimension				Depth			
in.	mm.	in.	mm.		Black	in.	mm.	in.	mm.	
.58	14,7	.68	17,3	14 - 20	<b>G5320</b>	PST E-75-14	.75	19,1	.43	10,9
.73	18,5	.83	21,1	10 - 14	<b>G5321</b>	PST E-100-10	1.00	25,4		
.83	21,1	.93	23,6	14 - 20	<b>G5322</b>	PST E-100-14				
1.08	27,4	1.18	30,0	14 - 20	<b>G5323</b>	PST E-125-14	1.25	31,8	.52	13,2
1.23	31,2	1.33	33,8	10 - 14	<b>G5324</b>	PST E-150-10	1.50	38,1		
1.33	33,8	1.43	36,3	14 - 20	<b>G5325</b>	PST E-150-14				
1.73	43,9	1.83	46,5	14 - 20	<b>G5326</b>	PST E-200-10	2.00	50,8		

Standard color black.

## Heyco® Plugs for Rectangular Tubing

### PZT Series - Ribbed Fit

TUBE DIMENSIONS						PART NO.	DESCRIPTION	PLUG Depth C		
Outside Dimensions				Wall Thickness	Typical Gauge			Black	in.	mm.
A		B								
in.	mm.	in.	mm.	in.						
.50	12,7	1.00	25,4	.065 - .049	16 - 18	<b>G5330</b>	PZT 50-100-16	.43	10,9	
		1.50	38,1	.083 - .035	14 - 20	<b>G5331</b>	PZT 50-150-14	.50	12,7	
.63	15,9	1.12	28,6	.083 - .035	14 - 20	<b>G5332</b>	PZT 63-112-14	.43	10,9	
		1.25	31,8	.083	14	<b>G5334</b>	PZT 63-125-14	.50	12,7	
		1.38	34,9	.083 - .035	14 - 20	<b>G5335</b>	PZT 63-138-14	.43	10,9	
.75	19,1	1.50	38,1	.083 - .035	14 - 20	<b>G5336</b>	PZT 75-150-14	.43	10,9	
		1.25	31,8	.083 - .035	14 - 20	<b>G5337</b>	PZT 100-125-14	.50	12,7	
1.00	25,4	1.50	38,1	.134 - .083	10 - 14	<b>G5338</b>	PZT 100-150-10			
				.083 - .035	14 - 20	<b>G5339</b>	PZT 100-150-14			
		2.00	50,8	.134 - .083	10 - 14	<b>G5340</b>	PZT 100-200-10			
				.083 - .035	14 - 20	<b>G5341</b>	PZT 100-200-14*			
		.065	16	<b>G5342</b>	PZT 100-200-16	.36	9,1			
				.083 - .035	14 - 20	<b>G5343</b>	PZT 100-250-14			.45
2.50	63,5	.065 - .049	16 - 18	<b>G5344</b>	PZT 100-250-16	.50	12,7			
		.083 - .035	14 - 20	<b>G5345</b>	PZT 100-300-14	.51	13,0			
1.50	38,1	2.00	50,8	.134 - .083	10 - 14	<b>G5346</b>	PZT 150-200-10	.50	12,7	
		2.50	63,5	.109 - .065	12 - 16	<b>G5347</b>	PZT 150-250-12	.53	13,5	
		3.00	76,2	.134 - .083	10 - 14	<b>G5348</b>	PZT 150-300-10	.50	12,7	
		3.50	88,9	.134 - .083	10 - 14	<b>G5349</b>	PZT 150-350-10	.60	15,2	
1.96	49,8	3.94	100,1	.203 - .109	6 - 12	<b>G5356</b>	PZT 196-394-06M	.65	16,5	
2.00	50,8	2.50	63,5	.134 - .083	10 - 14	<b>G5351</b>	PZT 200-250-10	.52	13,2	
				.203 - .165	6 - 8	<b>G5352</b>	PZT 200-300-06			
		3.00	76,2	.134 - .083	10 - 14	<b>G5353</b>	PZT 200-300-10	.50	12,7	
				.083 - .035	14 - 20	<b>G5354</b>	PZT 200-300-14			
		.203 - .120	6 - 11	<b>G5355</b>	PZT 200-400-06	.94	23,9			
				.134 - .083	10 - 14	<b>G5357</b>	PZT 200-400-10	.50	12,7	
		.083 - .035	14 - 20	<b>G5358</b>	PZT 200-400-14					
				5.00	127,0	.165	8	<b>G5359</b>	PZT 200-500-08*	1.00
.134	10	<b>G5360</b>	PZT 200-500-10*							

Standard color black.

\*Smooth (ie, not ribbed) shank.

Material	PSTE	Material	LDPE
Temperature Range	Vinyl 26°F (-32°C) to 200°F (93°C)	Temperature Range	-94°F (-70°C) to 150°F (66°C)



- **Flexible, ribbed design** allows quick and easy fingertip installation.
- **Removable without the use of tools** (Traditional glides and tube plugs are designed to be permanent. Their rigid design makes removal very difficult).
- Injection molded for intricate detail and design, with **flexibility**.
- See page 6-50 for HEYCaps and Plugs for Round Tubing.
- Material: Vinyl. Vinyl **decreases mobility** or sliding on floors, helping to keep your application in place.

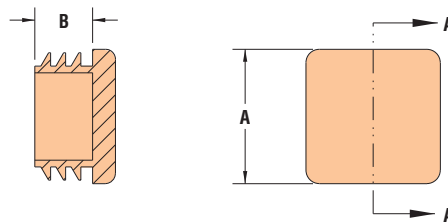

- Featuring the same external rib design of Heyco PSTR Series Plugs for Square Tubing, PZT Series Plugs for Rectangular Tubing are offered in a **broad selection of width-to-length proportions**, to fit many special tubing shapes found on stands for computer terminals, office machines, display fixtures, and similar metal furnishings and equipment.
- **Durable construction** ensures exceptional performance in business and commercial applications.

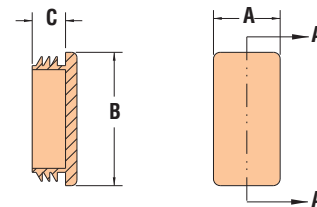



## Heyco® Stock and Custom\* Colors for Dome Plugs and Shorty Plugs

\*CUSTOM Color parts MUST be color matched. For accurate matching, consult Heyco for sample molded nylon color chips.

For complete Dome Plug Part Dimensions and Specifications, see page 6-25.

For complete Shorty Plug Part Dimensions and Specifications, see page 6-27.

- Heyco Stock and Custom Colors are Molded-in, not dyed, Colors.
- Stock and Custom Color Minimum Order Quantities are usually higher than for Black and White parts.
- **STOCK** Color means the color concentrate pellets are in stock at Heyco.
- The Stock Colors shown are **approximate**. Consult Heyco for Stock Color molded nylon color chips.
- Stock Color lead times are typically 2-3 weeks from receipt of order.
- For Stock Color part numbers in other Plug styles, for example Glossy or Double D Plugs, please consult Heyco.
- **CUSTOM** Color parts MUST be color matched to your application. For accurate matching, consult Heyco for sample molded nylon color chips.
- Custom Color lead times are typically 4 weeks from receipt of order.
- We offer Stock and Custom Colors in virtually all of our nylon molded products.
- Heyco’s Axcell Rapid Response Team is ready to customize your Plug in various sizes, shapes, materials, and colors. We can even mold your Company logo directly onto your Plug!

MOUNTING HOLE DIA.		PLUG TYPE	ROOT PART NO.	STOCK COLOR PART NUMBER SUFFIX										YOUR CUSTOM COLOR HERE
in.	mm.			FK	FL	FJ	EH	CS	DD	CF	DQ	FI	xx **	
.218	5,5	Shorty	1656	FK	FL	FJ	EH	CS	DD	CF	DQ	FI	xx	
.250	6,4	Dome	2605	FK	FL	FJ	EH	CS	DD	CF	DQ	FI	xx	
.281	7,1	Shorty	1662	FK	FL	FJ	EH	CS	DD	CF	DQ	FI	xx	
.312	7,9	Dome	2615	FK	FL	FJ	EH	CS	DD	CF	DQ	FI	xx	
		Shorty	1680	FK	FL	FJ	EH	CS	DD	CF	DQ	FI	xx	
.343	8,7	Shorty	1665	FK	FL	FJ	EH	CS	DD	CF	DQ	FI	xx	
		Dome	2619	FK	FL	FJ	EH	CS	DD	CF	DQ	FI	xx	
.375	9,5	Shorty	1683	FK	FL	FJ	EH	CS	DD	CF	DQ	FI	xx	
		Dome	2635	FK	FL	FJ	EH	CS	DD	CF	DQ	FI	xx	
.437	11,1	Shorty	1686	FK	FL	FJ	EH	CS	DD	CF	DQ	FI	xx	
		Dome	2645	FK	FL	FJ	EH	CS	DD	CF	DQ	FI	xx	
.500	12,7	Shorty	1689	FK	FL	FJ	EH	CS	DD	CF	DQ	FI	xx	
		Dome	2655	FK	FL	FJ	EH	CS	DD	CF	DQ	FI	xx	
.531	13,5	Shorty	1674	FK	FL	FJ	EH	CS	DD	CF	DQ	FI	xx	
.562	14,3	Dome	2655	FK	FL	FJ	EH	CS	DD	CF	DQ	FI	xx	
.625	15,9	Dome	2665	FK	FL	FJ	EH	CS	DD	CF	DQ	FI	xx	
		Shorty	1692	FK	FL	FJ	EH	CS	DD	CF	DQ	FI	xx	
.687	17,4	Dome	2675	FK	FL	FJ	EH	CS	DD	CF	DQ	FI	xx	
		Dome	2685	FK	FL	FJ	EH	CS	DD	CF	DQ	FI	xx	
.750	19,1	Shorty	1695	FK	FL	FJ	EH	CS	DD	CF	DQ	FI	xx	
		Dome	2695	FK	FL	FJ	EH	CS	DD	CF	DQ	FI	xx	
.875	22,2	Shorty	1701	FK	FL	FJ	EH	CS	DD	CF	DQ	FI	xx	
		Dome	2705	FK	FL	FJ	EH	CS	DD	CF	DQ	FI	xx	
1.000	25,4	Shorty	1704	FK	FL	FJ	EH	CS	DD	CF	DQ	FI	xx	
		Dome	2715	FK	FL	FJ	EH	CS	DD	CF	DQ	FI	xx	
1.093-	27,8-	Dome	2725	FK	FL	FJ	EH	CS	DD	CF	DQ	FI	xx	
1.125	28,6	Shorty	1707	FK	FL	FJ	EH	CS	DD	CF	DQ	FI	xx	
1.187	30,1	Dome	2735	FK	FL	FJ	EH	CS	DD	CF	DQ	FI	xx	
1.250	31,7	Dome	2742	FK	FL	FJ	EH	CS	DD	CF	DQ	FI	xx	
1.375	34,9	Dome	2755	FK	FL	FJ	EH	CS	DD	CF	DQ	FI	xx	
1.500	38,1	Dome	2765	FK	FL	FJ	EH	CS	DD	CF	DQ	FI	xx	
1.750	44,5	Dome	2775	FK	FL	FJ	EH	CS	DD	CF	DQ	FI	xx	
2.000	50,8	Dome	2785	FK	FL	FJ	EH	CS	DD	CF	DQ	FI	xx	
2.5	63,5	Dome	2792	FK	FL	FJ	EH	CS	DD	CF	DQ	FI	xx	
3.0	76,2	Dome	2457	FK	FL	FJ	EH	CS	DD	CF	DQ	FI	xx	

\*\* xx indicates that, following the color match process, Heyco will add a two letter suffix to the Root Part Number shown. This suffix will identify your particular CUSTOM Color selection. Consult Heyco for molded nylon color chips for accurate matching.



Your logo here





## Heyco® Vent Plugs and Thick Panel Vent Plugs

Mounting Hole Diameter Range: .500" (12,7 mm) to 4.000" (101,6 mm)

MOUNTING HOLE DIAMETER		PART NO.		DESCRIPTION	No. of Vent Holes	PART DIMENSIONS		B	
in.	mm.	Black	White			Head Diameter	Overall Height	in.	mm.

**Multiple Locking Steps for Panel Thickness up to .125" (3,2 mm)**

.500	12,7	<b>2637</b>	<b>2638</b>	VP 500	4	.56	14,2	.41	10,3
.562	14,3	<b>2647</b>	-	VP 562	4	.66	16,7		
.625	15,9	<b>2657</b>	<b>2658</b>	VP 625	5	.73	18,7		
.750	19,1	<b>2677</b>	<b>2678</b>	VP 750	8	.91	23,0		
.812	20,6	<b>2688</b>	<b>2689</b>	VP 812	8	.89	22,6		
.875	22,2	<b>2697</b>	<b>2698</b>	VP 875	9	1.02	25,8		
1.000	25,4	<b>2707</b>	<b>2708</b>	VP 1000	9	1.20	30,6	.45	11,5
1.093 - 1.125	27,8 - 28,6	<b>2726</b>	<b>2727</b>	VP 1093	9	1.22	30,9		
1.187	30,1	<b>2736</b>	<b>2737</b>	VP 1187	10	1.31	33,3		
1.250	31,7	<b>2743</b>	<b>2744</b>	VP 1250	10	1.38	34,9		
		<b>2797</b>	-	SVP 1250-4	4				
1.375	34,9	<b>2756</b>	<b>2757</b>	VP 1375	11	1.50	38,1		
1.500	38,1	<b>2766</b>	<b>2767</b>	VP 1500	13	1.67	42,4		
1.750	44,5	<b>2776</b>	<b>2777</b>	VP 1750	13	1.91	48,4		
2.000	50,8	<b>2786</b>	<b>2787</b>	VP 2000	19	2.14	54,4	.47	11,9

**Multiple Locking Steps for Panel Thickness up to .250" (6,4 mm)**

.500	12,7	<b>3010</b>	<b>3011</b>	VPT 500	4	.58	14,7	.56	14,3
.625	15,9	<b>3013</b>	<b>3014</b>	VPT 625	5	.73	18,7		
.750	19,1	<b>2426</b>	<b>2427</b>	VPT 750	8	.91	23,0		
.875	22,2	<b>3152</b>	<b>3153</b>	VPT 875	9	1.02	25,8		
1.000	25,4	<b>3154</b>	<b>3155</b>	VPT 1000	9	1.20	30,6		
1.093 - 1.125	27,8 - 28,6	<b>3032</b>	<b>3033</b>	VPT 1093	9	1.22	30,9		
1.187	30,1	<b>3160</b>	<b>3161</b>	VPT 1187	10	1.31	33,3	.58	14,7
1.250	31,7	<b>3034</b>	<b>3035</b>	VPT 1250	10	1.38	34,9		
1.375	34,9	<b>3036</b>	<b>3037</b>	VPT 1375	11	1.50	38,1		
1.500	38,1	<b>3156</b>	<b>3157</b>	VPT 1500	13	1.67	42,4		
1.750	44,5	<b>3038</b>	<b>3039</b>	VPT 1750	13	1.91	48,4		
2.000	50,8	<b>3158</b>	<b>3159</b>	VPT 2000	19	2.14	54,4		
2.500	63,5	<b>2793</b>	<b>2794</b>	VP 2.5	19	2.72	69,0	.75	19,1
3.000	76,2	<b>2458</b>	<b>2459</b>	VP 3.0	26	3.15	80,0	.74	18,8
3.500	88,9	<b>2467</b>	<b>2468</b>	VP 3.5	38	3.66	92,9	.75	19,1
4.000	101,6	<b>2476</b>	<b>2477</b>	VP 4.0	48	4.16	105,6		

Standard color black. Consult Heyco for other colors.

- Permit the passage of air for ventilation and heat dissipation.
- Quick and easy installation with only fingertip pressure.
- Convex, matte finish head tapers to a thin edge.
- VP-500 through VP-875 have .094" (2,4 mm) diameter vent holes. All other sizes have .125" (3,2 mm) diameter vents.
- Lock firmly into panel up to .250" (6,4 mm) thick.
- Locking fingers in fractional increments up to the maximum panel thickness.
- Multiple sizes for use in .500" (12,7 mm) to 4.000" (101,6 mm) diameter holes.
- Approximate Head Thickness: .062" (1,6 mm). Thickness may vary.
- Heyco Louvered Plugs available, see page 6-56.

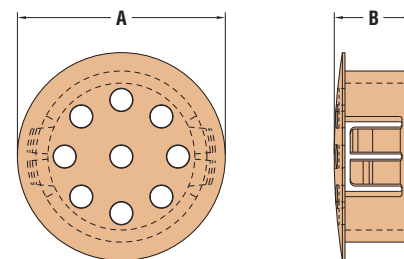

Material  
Certifications

Nylon 6/6

Recognized under the Component Program of Underwriters' Laboratories, File E51579

Certified by Canadian Standards Association, File 8919

Flammability Rating  
Temperature Range

94V-2

-40°F (-40°C) to 221°F (105°C)

*Quick Specs*



- Filter inserts permit the passage of air for ventilation but limit liquid as well as dust and pest infiltration.
- Polyurethane foam filter will filter particle sizes 30 micron and larger.
- Filter is captive in body of vent plug and uses no additional real estate inside.

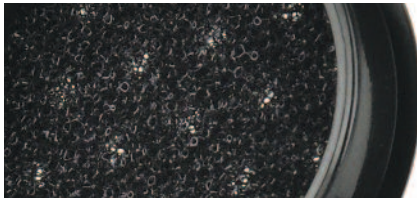

## HEYClean™ Filter Insert Vent Plugs

Mounting Hole Diameter Range: .500" (12,7 mm) to 3.000" (76,2 mm)

MOUNTING HOLE DIAMETER		PART NO. Black	DESCRIPTION	No. of Vent Holes	PART DIMENSIONS			
in.	mm.				A Head Diameter		B Overall Height	
					in.	mm.	in.	mm.
Multiple Locking Steps for Panel Thickness up to .125" (3,2 mm)								
.500	12,7	<b>4917</b>	FIVP 500	4	.56	14,2	.41	10,4
.875	22,2	<b>4919</b>	FIVP 875	9	1.02	25,8	.45	11,5
1.000	25,4	<b>4921</b>	FIVP 1000	9	1.20	30,6		
1.093 - 1.125	27,8 - 28,6	<b>4923</b>	FIVP 1093	9	1.22	30,9		
1.375	34,9	<b>4931</b>	FIVP 1375	11	1.50	38,1	.47	11,9
1.500	38,1	<b>4933</b>	FIVP 1500	13	1.67	42,4		
2.000	50,8	<b>4937</b>	FIVP 2000	19	2.14	54,4		
Multiple Locking Steps for Panel Thickness up to .250" (6,4 mm)								
.875	22,2	<b>4973</b>	FIVPT 875	9	1.02	25,8	.56	14,3
1.000	25,4	<b>4975</b>	FIVPT 1000	9	1.20	30,6		
1.093 - 1.125	27,8 - 28,6	<b>4977</b>	FIVPT 1093	9	1.22	30,9		
1.375	34,9	<b>4983</b>	FIVPT 1375	11	1.50	38,1	.58	14,7
1.500	38,1	<b>4985</b>	FIVPT 1500	13	1.67	42,4		
2.000	50,8	<b>4989</b>	FIVPT 2000	19	2.14	54,4		
2.500	63,5	<b>4939</b>	FIVP 2.5	19	2.72	69,0	.75	19,1
3.000	76,2	<b>4941</b>	FIVP 3.0	26	3.15	80,0	.74	18,8

Standard color black. Consult Heyco for other colors.

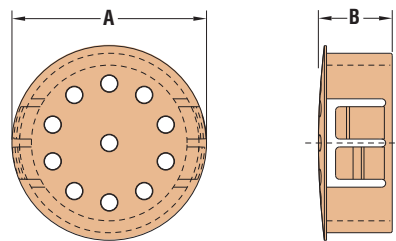

*Quick Specs*

Material: Nylon 6/6  
 Flammability Rating: 94V-2  
 Temperature Range: -40°F (-40°C) to 221°F (105°C)



## Heyco® Louvered Plugs

Mounting Hole Diameter Range: .875" (22,2 mm) to 3.000" (76,2 mm)

MOUNTING HOLE DIAMETER		PART NO. Black	DESCRIPTION	PART DIMENSIONS			
in.	mm.			A Head Diameter		B Overall Height	
Multiple Locking Steps for Panel Thickness up to .125" (3,2 mm)							
.875	22,2	2557	LP 875	1.02	25,8	.53	13,5
1.000	25,4	2559	LP 1000	1.21	30,6		
1.093 - 1.125	27,8 - 28,6	2561	LP 1093	1.22	30,9	.54	13,8
1.375	34,9	2567	LP 1375	1.50	38,1		
1.500	38,1	2569	LP 1500	1.68	42,6		
2.000	50,8	2594	LP 2000	2.17	55,1		
Multiple Locking Steps for Panel Thickness up to .250" (6,4 mm)							
2.500	63,5	2596	LP 2.5	2.72	69,0	.82	20,9
3.000	76,2	2598	LP 3.0	3.17	80,5		

Standard color black. Consult Heyco for other colors.

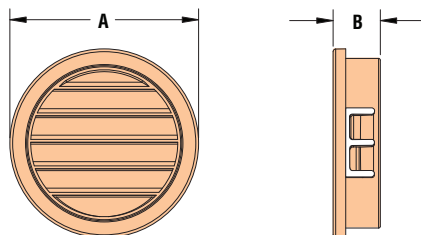

## HEYClean™ Filter Insert Louvered Plugs

Mounting Hole Diameter Range: .875" (22,2 mm) to 3.000" (76,2 mm)

MOUNTING HOLE DIAMETER		PART NO. Black	DESCRIPTION	PART DIMENSIONS			
in.	mm.			A Head Diameter		B Overall Height	
Multiple Locking Steps for Panel Thickness up to .125" (3,2 mm)							
.875	22,2	4947	FILP 875	1.02	25,8	.53	13,5
1.000	25,4	4949	FILP 1000	1.21	30,6		
1.093 - 1.125	27,8 - 28,6	4951	FILP 1093	1.22	30,9	.54	13,8
1.375	34,9	4957	FILP 1375	1.50	38,1		
1.500	38,1	4959	FILP 1500	1.68	42,6		
2.000	50,8	4963	FILP 2000	2.17	55,1		
Multiple Locking Steps for Panel Thickness up to .250" (6,4 mm)							
2.500	63,5	4965	FILP 2.5	2.72	69,0	.82	20,9
3.000	76,2	4967	FILP 3.0	3.17	80,5		

Standard color black. Consult Heyco for other colors.

Material: Nylon 6/6  
 Flammability Rating: 94V-2  
 Temperature Range: -40°F (-40°C) to 221°F (105°C)



- Louvers permit the passage of air for ventilation but limit liquid infiltration.
- Suitable for ventilation in electronic enclosures, motor housings and metal or plastic panels.
- Quick and easy installation with flexible orientation of louver direction.
- Withstand a push back force of 35 lbs. (47 Nm).
- Lock firmly into panel up to .250" (6,4 mm) thick.
- Locking fingers in fractional increments up to the maximum panel thickness.
- Heyco Vent Plugs, Heyco Thick Panel Vent Plugs, and Heyco Liquid Tight Threaded Vent Plugs also available.



- Located behind the louvers, filter inserts permit the passage of air for ventilation but limit liquid as well as dust and pest infiltration.
- Polyurethane foam filter will filter particle sizes 30 micron and larger.



*Quick Specs*



- Permit the passage of air for ventilation and heat dissipation.
- Quick and easy installation into Threaded Holes.
- For multiple thread sizes and types.
- All sizes and types feature seven (7) .094" (2,4 mm) diameter vent holes.
- Threaded plugs for hydraulic and pneumatic applications.
- Lower cost option over brass or steel plugs.
- Non-corrosive-resist salt water, weak acids, gasoline, alcohol, oil, grease and common solvents. Resist oil and heat up to 221°F (105°C).
- Approximate Head Thickness: .21" (5,3 mm). Thickness may vary.
- Hex shaped head for wrench installation.
- Electrically non-conductive Nylon 6/6.
- For **Liquid Tight** Threaded Vent Plugs, see page 6-58.

## Heyco® Threaded Vent Plugs

Open vent holes only

THREAD Type/Size	PART NO.		DESCRIPTION	PART DIMENSIONS			
	Black	Gray		A Wrenching Flats in.   mm.		B Overall Length in.   mm.	
<b>NPT</b>							
NPT 1/4	<b>3551B</b>	<b>3551</b>	TVP NPT 1/4	.63	16,0	.66	16,8
NPT 3/8	<b>3552B</b>	<b>3552</b>	TVP NPT 3/8	.83	21,0	.69	17,5
NPT 1/2	<b>3553B</b>	<b>3553</b>	TVP NPT 1/2	.98	24,9	.81	20,6
NPT 3/4	<b>3554B</b>	<b>3554</b>	TVP NPT 3/4	1.29	32,8	.86	21,8
<b>PG - for PG Thread specifications, see page 3-49</b>							
Pg 7	<b>3566B</b>	<b>3566</b>	TVP Pg 7	.63	16,0	.53	13,5
Pg 9	<b>3567B</b>	<b>3567</b>	TVP Pg 9	.83	21,0	.62	15,8
Pg 13.5	<b>3568B</b>	<b>3568</b>	TVP Pg 13.5	.98	24,9	.76	19,3
Pg 21	<b>3569B</b>	<b>3569</b>	TVP Pg 21	1.29	32,8	.62	15,8
<b>Metric</b>							
M12	<b>3557B</b>	<b>3557</b>	TVP M12	.63	16,0	.53	13,5
M16	<b>3558B</b>	<b>3558</b>	TVP M16	.83	21,0	.62	15,8
M20	<b>3559B</b>	<b>3559</b>	TVP M20	.98	24,9	.62	15,8

Standard color Black. Consult Heyco for other colors.

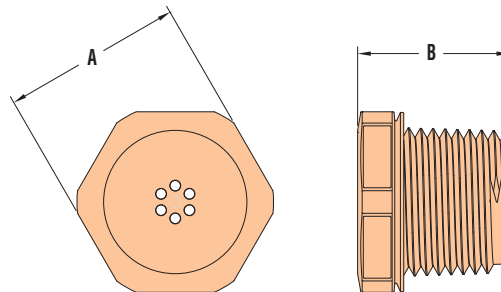

*Quick  
Specs*

Material	Nylon 6/6 bodies with UL (f1) rating
Flammability Rating	94V-2
Temperature Range	-40°F (-40°C) to 221°F (105°C)



NO O-RING  
REQUIRED!



## HEYClean™ Liquid Tight Threaded Vent Plugs

With Integral Sealing Ring and Liquid Tight Filter

THREAD Type/Size	PART NO.		DESCRIPTION	PART DIMENSIONS			
	Black	Gray		A Wrenching Flats in.   mm.		B Overall Length in.   mm.	
<b>NPT</b>							
NPT 1/4	3544VB	3544V	LTTVP NPT 1/4	.63	16,0	.66	16,8
NPT 3/8	3545VB	3545V	LTTVP NPT 3/8	.83	21,0	.69	17,5
NPT 1/2	3546VB	3546V	LTTVP NPT 1/2	.98	24,9	.81	20,6
NPT 3/4	3547VB*	3547V*	LTTVP NPT 3/4	1.29	32,8	.86	21,8
<b>PG - For PG Thread specifications, see page 3-49</b>							
Pg 7	3574VB	3574V	LTTVP Pg 7	.63	16,0	.53	13,5
Pg 9	3575VB	3575V	LTTVP Pg 9	.83	21,0		
Pg 13.5	3576VB	3576V	LTTVP Pg 13.5	.98	24,9	.62	15,8
Pg 21	3401VB	3401V	LTTVP Pg 21	1.29	32,8	.76	19,3
<b>Metric</b>							
M12	3582VB	3582V	LTTVP M12	.63	16,0	.53	13,5
M16	3583VB	3583V	LTTVP M16	.83	21,0		
M20	3584VB	3584V	LTTVP M20	.98	24,9	.62	15,8

Standard color Black. Consult Heyco for other colors.

\*IP 65 rated.

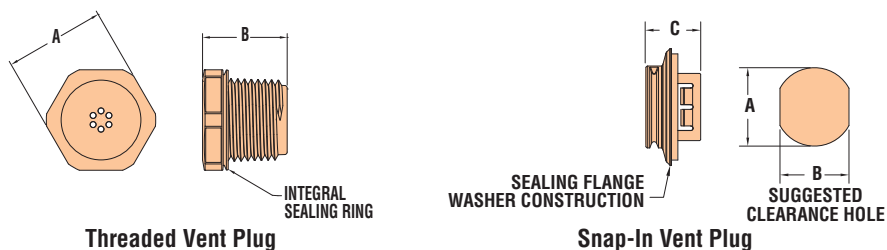

- Integral sealing ring ensures a **superior seal** at mounting hole location, every time; **IP 67 and 68 Rated**.
- Allow the passage of air for ventilation and heat dissipation, yet prevent moisture intrusion, remain liquid tight.
- Maximum airflow:  $\geq 16.6$  LPM/3.7cm<sup>2</sup> @ 13.5 psi.
- UL Rated for Type NEMA 3R, 4, and 4X applications.
- Filter membrane prevents moisture and particulate contamination in electronic enclosures.
- Pressure compensating seal prevents buildup of pressure inside of electronic enclosures due to environmental temperature cycling.
- Quick and easy installation into Threaded (LTTVP) and Clearance (LTSV) holes.
- Membrane seal is ultrasonically welded to nylon body.
- Lower cost option over metal or steel plugs.
- Approximate Head Thickness: .21" (5,3 mm). Thickness may vary.
- Hex shaped head for wrench installation (LTTVP only).
- Electrically non-conductive Nylon 6/6.
- Quick and easy **Snap-in** installation into Clearance Holes.
- All sizes and types feature (9) .094" (2,4 mm) diameter vent holes.
- **Snap-In** plugs for panel and housing applications.
- Lower cost option over brass or steel plugs.
- Snap into a range of panel thicknesses up to .125" (3,2 mm) with no tools (LTSV only).

## HEYClean™ Liquid Tight Snap-In Vent Plugs

With Integral Sealing Flange/Washer and Liquid Tight Filter

Mounting Hole Diameter Range: .500" (12,7 mm) to 1.125" (28,6 mm)

A Mounting Hole Dia.*	PART NO.	DESCRIPTION	PART DIMENSIONS			
			B To Prevent Rotation		C Max. O.A. Length	
in.   mm.	Black		in.	mm.	in.	mm.
.500   12,7	3481VB	LTSV 500	.45	11,4	.600	15,2
.875   22,2	3486VB	LTSV 875	.77	19,6	.620	15,7
1.125   28,6	3488VB	LTSV 1125	1.00	25,4	.660	16,8

Standard color black. Consult Heyco for other colors.

\* Consult Heyco for additional sizes.

Material	Nylon 6/6 bodies with an Acrylic Copolymer Filter
Certifications	Recognized under the Component Program of Underwriters' Laboratories, File E330194 to both Canadian and U.S. Requirements
Flammability Rating	94V-2
Temperature Range	-40°F (-40°C) to 221°F (105°C)
IP Rating	IP 65/67/68

Quick  
Specs



**Pressure Equalization Plugs**

- Allow the passage of air for ventilation and heat dissipation, yet prevent moisture intrusion.
- Filter membrane prevents moisture and particulate contamination in electronic enclosures.
- Pressure compensating seal prevents buildup of pressure inside of electronic enclosures due to environmental temperature cycling.
- Quick and easy installation into Clearance or Threaded Holes.
- **Nickel-plated finish over brass provides excellent corrosion resistance and durability.**
- Head Thickness: .37” (9,5 mm) to .39” (10 mm).
- Hex shaped body for wrench installation.
- Filter element:  
Liquid Tight Membrane: Polyethersulfone (PES)  
Sintered Disc: Bronze
- DFARS Compliant

**Drain Plugs**

- Drainage Plugs are ideal for applications where condensation is expected.
- Stainless steel mesh allows water to drain quickly, but protects enclosure from bugs and dust.
- Drainage Plugs feature a “cutout” section to allow water to completely drain from enclosure, and should be installed at enclosure’s lowest point.
- Head Thickness: .37” (9,5 mm) to .39” (10 mm).
- Hex shaped body for wrench installation.
- DFARS Compliant

**Drain Plug Locknuts**

- Quick and easy installation into Clearance Holes only.
- Locknuts feature special “cutout” to allow water to completely drain from enclosure, when used with HEYClean™ Threaded Drain Plugs.
- DFARS Compliant

**HEYClean® Brass Pressure Equalization and Drain Plugs**

For Pressure Equalization and Drainage Applications

THREAD Type/Size	PART NO.	DESCRIPTION	PART DIMENSIONS								PROTECTION CLASS
			A Clearance Hole		B Overall Length		C Thread Length		D Wrenching Flats		
			in.	mm.	in.	mm.	in.	mm.	in.	mm.	

**Liquid Tight Pressure Equalization Plugs - Ultimate in Liquid Tight Pressure Equalization**

M12 x 1.5	<b>4350</b>	BRASS LTPEP M12	.47	12,0	.69	17,5	.31	8,0	.71	18,0	IP 66,67,68
M16 x 1.5	<b>4351</b>	BRASS LTPEP M16	.63	16,0	.71	18,0	.31	8,0	.87	22,0	
M20 x 1.5	<b>4352</b>	BRASS LTPEP M20	.79	20,0	.71	18,0	.31	8,0	.87	22,0	

**Liquid Resistant Pressure Equalization Plugs - Maximize Airflow for Extreme Pressure and Moisture Fluctuations**

M12 x 1.5	<b>4354</b>	BRASS LRPEP M12	.47	12,0	.69	17,5	.31	8,0	.71	18,0	IP 55, x9K
M16 x 1.5	<b>4355</b>	BRASS LRPEP M16	.63	16,0	.71	18,0	.31	8,0	.87	22,0	
M20 x 1.5	<b>4356</b>	BRASS LRPEP M20	.79	20,0	.71	18,0	.31	8,0	.87	22,0	

**Threaded Drain Plug - For Applications Where Condensation Is Expected\***

M12 x 1.5	<b>4357</b>	BRASS TDP M12	.47	12,0	.77	19,5	.39	10,0	.71	18,0	IP 4x
M16 x 1.5	<b>4358</b>	BRASS TDP M16	.63	16,0	.77	19,5	.39	10,0	.87	22,0	
M20 x 1.5	<b>4359</b>	BRASS TDP M20	.79	20,0	.77	19,5	.39	10,0	.87	22,0	

Stainless Steel available. Consult Heyco.

\*Heyco Drainage Plug Brass Locknuts sold separately

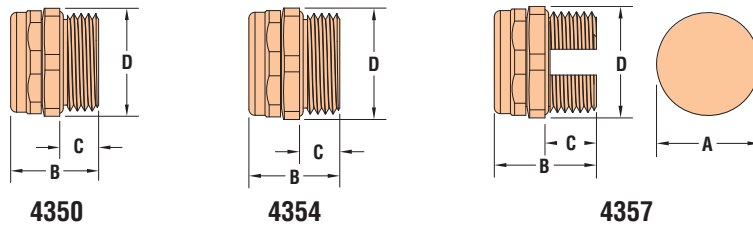

**HEYClean® Drain Plug Brass Locknuts**

For Use with HEYClean™ Threaded Drain Plugs

THREAD Type/Size	PART NO.	DESCRIPTION	PART DIMENSIONS			
			A Thickness		B Wrenching Flats	
			in.	mm.	in.	mm.
M12 x 1.5	<b>4360</b>	BRASS DPLN M12	.18	4,5	.59	15,0
M16 x 1.5	<b>4361</b>	BRASS DPLN M16	.22	5,5	.75	19,0
M20 x 1.5	<b>4362</b>	BRASS DPLN M20	.22	5,5	.94	24,0

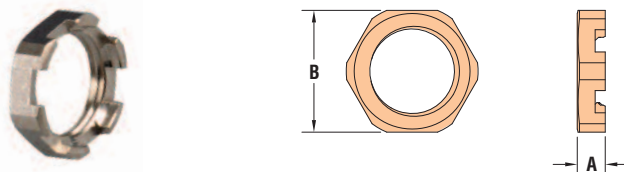

Material	Nickel-Plated Brass
Temperature Range	-40°F (-40°C) to 230°F (110°C)
IP Rating	Membrane - IP66/IP68/IP69 Filter Disc - IP55/ IPX9K Drainage Element - IP4X

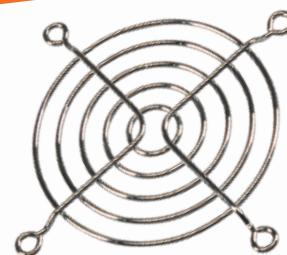

## Heyco® Fan Guards

- Good corrosion resistance, easy to clean.
- Screw mount.
- Material: Steel wire Electroplated; Nickel Chrome finish.

NO. Rings	PART NO.	DESCRIPTION	PART DIMENSIONS								STYLE
			A		B		C		D		
			in.	mm.	in.	mm.	in.	mm.	in.	mm.	
2	0975	FG 25	.94	24,0	1.24	31,4	.12	2,2	.14	3,5	1
	0976	FG 40	1.15	29,1	1.26	32,0	.19	4,8	.16	4,0	
3	0977	FG 50	1.62	41,1	1.57	40,0	.19	4,8	.18	4,6	2
4	0978	FG 60	2.09	53,2	1.97	50,0	.17	4,4	.19	4,8	
5	0979	FG 80	2.99	76,0	2.82	71,5	.22	5,5	.19	4,8	
6	0980	FG 92	3.54	90,0	3.25	82,5	.22	5,5	.18	4,6	
8	0981	FG 120	4.55	115,6	4.13	105,0	.22	5,5	.18	4,6	3
10	0982	FG 150	6.08	154,4	6.38	162,1	.26	6,5	.19	4,8	

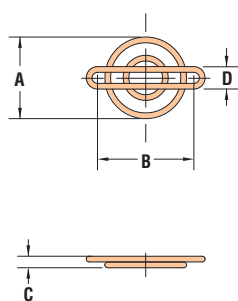

Style 1

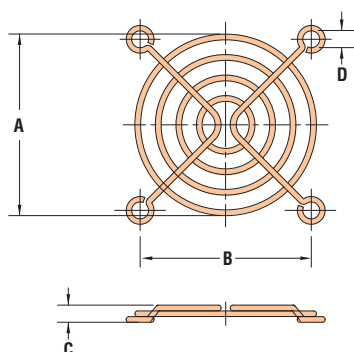

Style 2

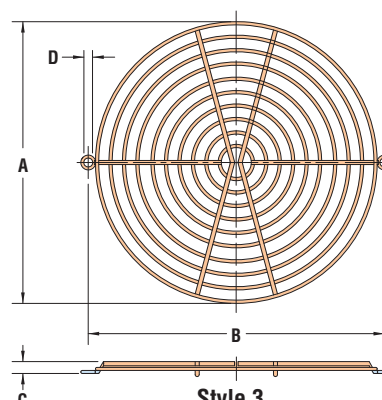

Style 3

## Heyco® Fan Guard Rivets

WILL FIT THESE PANELS					PART NO. Black	DESCRIPTION	PART DIMENSIONS						EXTRACTION FORCE	
MOUNTING HOLE DIA.		PANEL THICKNESS					A Length	B Head Height	C Head Diameter	Lbs	Kg			
in.	mm.	Min.	Max.	in.								mm.		
<b>Snap Style</b>					9326	PR 124-807	.91	23,0	.06	1,6	.25	6,4	17,6	8
.124	3,1	.81	20,5	.85										
<b>Push Style</b>					9327	DR 137-807	.91	23,0	.03	0,8	.20	5,0	17,6	8
.137	3,5	.81	20,5	.85										

UL94V-2 Nylon 6 - both Rivets

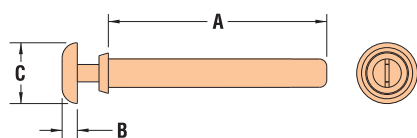

Snap Style

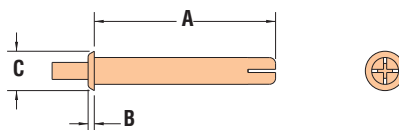

Push Style

- Permanently mount fan to chassis or finger guards to fan.
- Provide tamper resistant application.
- Prongs expand to hold securely as pin is driven.
- Single-operation front mounting saves time and money.
- Low profile head.
- Installed by hand or with installation tool.
- Part Description Key: PR/DR XXX-YYY where XXX = Mounting Hole Diameter (inches) and YYY = minimum Panel Thickness (inches).

Rivets	
Material	Nylon 6/6
Flammability Rating	94V-2
Temperature Range	-4°F (-18°C) to 185°F (85°C)

Quick Specs



## Heyco® Fan Mounts

PANEL DIMENSIONS				FAN DIMENSIONS				PART	DESCRIPTION	MAT'L	PART DIMENSIONS						STYLE			
Max. Panel Thickness		Mounting Hole Dia.		Mounting Hole Dia.		Thickness					A		B		C					
in.	mm.	in.	mm.	in.	mm.	in.	mm.	in.	mm.	in.	mm.	in.	mm.							
<b>FMS - Standard</b>																				
.055	1,4	.197	5,0	.20	5,0	.08	2,0	<b>0345</b>	FMS-1	EPDM 30	.06	1,5	.07	1,9	1,27	32,3	1			
									FMS-2	EPDM 40										
										<b>0348</b>	20,0	FMS-3	EPDM 30	.06	1,5	.12	3,0	.87	22,2	2
								FMS-4	EPDM 40											
.031	0,8	.138	3,5	.14	3,5	.79	20,0	<b>0354</b>	FMS-5	Silicone Rubber 40	.06	1,5	.73	18,5	2,20	56,0				
.118	3,0	.169	4,3	.17	4,3	.59	15,0		FMS-6	Silicone Rubber 40							.08	2,0	.55	14,0
.031	0,8	.138	3,5	.14	3,5	.98-1.10	25,0-28,0	<b>0356</b>	FMS-7	Silicone Rubber 40	.06	1,5	.94	24,0	2,87	73,0				
<b>FMM - Multi</b>																				
.039-.059	1,0-1,5	.177-.189	4,5-4,8	.13-.18	3,2-4,5	.39-2.00	10,0-51,0	<b>0357</b>	FMM-1	Silicone Rubber 40	see schematic drawing					4				
<b>FMB - Break-Away</b>																				
.031-.063	0,8-1,6	.177-.197	4,5-5,0	.16-.18	4,0-4,5	.98-2.01	25,0-51,0	<b>0359</b>	FMB-1	Silicone Rubber 40	see schematic drawing					5				
				.13-.14	3,2-3,5	up to .40	up to 10,0		<b>0363</b>	FMB-2	Silicone Rubber 40	see schematic drawing					6			
						.16-.18	4,0-4,5	up to .98		up to 25,0										

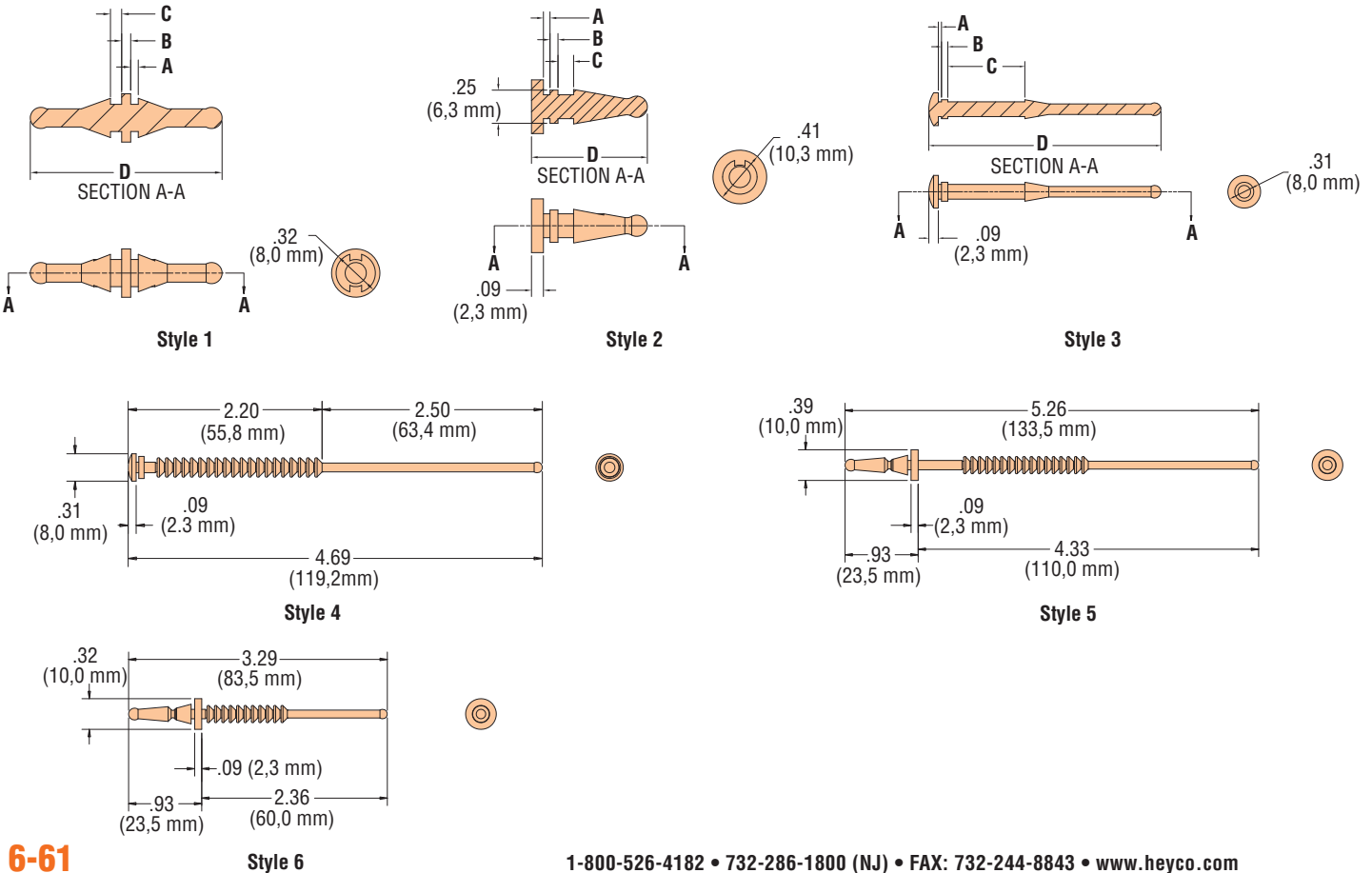



**“Stay Connected with Heyco” HEYCaps, Nylon Finishing Plugs & Venting Solutions**

**HEYCO**



## The Strain Reliever™ “Pill Bottle” (PN 9977)

**Request one from your Heyco Distributor, Sales Representative, Business Development Manager, or Customer Service Representative—TODAY!  
HEYCO FOR YOUR BUSINESS HEALTH**

### **INDICATIONS:**

For permanent **relief of strain** associated with not having the solution.

### **DIRECTIONS:**

Remove top and shake out a potential solution. Take one dose each time **“no solution”** symptoms appear. Repeat as needed. This prescription may be refilled at any time because new solutions are constantly being generated.

### **WARNING:**

If strain persists or gets worse, consult your Heyco representative immediately because this could be a sign of a serious problem in need of a Heyco solution!



**“Stay Connected with Heyco” Power Components**

**Phone: 732.286.1800 • Toll Free: 800.526.4182  
Fax: 732.244.8843 • Toll Free Fax: 800.358.7904  
www.heyco.com**

©Copyright, Heyco Products, Inc., 2015 Rev. 10/15 Printed in USA

Heyco®, HEYClean™, HEYCap™, TEMPlugs™, and HEYCo-molded™ are trademarks of Heyco Products, Inc.